

**CONTENT GENERATION IN ENGINEERING
PHYSICS FOR 1ST SEMESTER AND 2ND
SEMESTER DIPLOMA ENGINEERING STUDENTS
OF ODISHA (UNDER EDUSAT PROGRAMME,
directorate of TECHNICAL EDUCATION &
TRAINING, ODISHA, CUTTACK)**

ENGINEERING PHYSICS

Prepared by:-

1. Smt. Pragati Das,

Senior Lecturer Maths & Sc,

Utkalmani Gopabandhu Institute of Engineering, Rourkela

2. Sri. Smarajit Biswal,

Lecturer Maths & Sc,

Government Polytechnic, Sambalpur

3. Smt. Arati Sarangi,

Lecturer Maths & Sc,

Government Polytechnic, Berhampur

Submitted by

Nodal Officer

Smt. Pragati Das, Sr. Lect. Maths. & Sc, U.G.I.E, Rourkela

CONTENTS

Unit- 1	DIMENSIONS AND VECTORS
UNIT- 2	CURVILINEAR MOTION & KINEMATICS
UNIT- 3	GRAVITATION, PLANETARY MOTION & SIMPLE HARMONIC MOTION
UNIT- 4	SOUND & ACCOUSTICS
Unit- 5	HEAT AND THERMODYNAMICS
Unit- 6	OPTICS
Unit- 7	MAGNETOSTATICS AND ELECTROSTATICS
Unit- 8	CURRENT ELECTRICITY & ELECTROMAGNETISM
Unit- 9	ELECTROMAGNETIC INDUCTION
Unit- 10	MODERN PHYSICS

UNIT-1

DIMENSIONS

AND

VECTORS

DIMENSION & DIMENSIONAL FORMULA OF PHYSICAL QUANTITIES-

Dimensions: Dimensions of a physical quantity are, the powers to which the fundamental units are raised to get one unit of the physical quantity.

The fundamental quantities are expressed with following symbols while writing dimensional formulas of derived physical quantities.

- Mass \rightarrow [M]
- Length \rightarrow [L]
- Time \rightarrow [T]
- Electric current \rightarrow [I]
- Thermodynamic temperature \rightarrow [K]
- Intensity of light \rightarrow [cd]
- Quantity of matter \rightarrow [mol]

Dimensional Formula : Dimensional formula of a derived physical quantity is the “expression showing powers to which different fundamental units are raised”.

Ex : Dimensional formula of Force $F \rightarrow [M^1 L^1 T^{-2}]$

Dimensional equation: When the dimensional formula of a physical quantity is expressed in the form of an equation by writing the physical quantity on the left hand side and the dimensional formula on the right hand side, then the resultant equation is called Dimensional equation.

Ex: Dimensional equation of Energy is $E = [M^1 L^2 T^{-2}]$.

Derivation of Dimensional formula of a physical quantity:-

The dimensional formula of any physical quantity can be derived in two ways.

i) Using the formula of the physical quantity :

Ex: let us derive dimensional formula of Force .

Force $F \rightarrow ma$;

substituting the dimensional formula of mass m
 $\rightarrow [M]$;

acceleration $\rightarrow [LT^{-2}]$

We get $F \rightarrow [M][LT^{-2}]$; $F \rightarrow [M^1 L^1 T^{-2}]$.

ii) Using the units of the derived physical quantity.

Ex: let us derive the dimensional formula of momentum.

Momentum (p) $\rightarrow \text{kg} - \text{m} - \text{sec}^{-1}$

kg is unit of mass $\rightarrow [M]$;

metre (m) is unit of length $\rightarrow [L]$;

sec is the unit of time $\rightarrow [T]$

Substituting these dimensional formulas in above equation we get

$$p \rightarrow [M^1 L^1 T^{-1}].$$

- **Quantities having no units, can not possess dimensions:**

The following physical quantities neither possess units nor dimensions.

Trigonometric ratios, logarithmic functions, exponential functions, coefficient of friction, strain, poisson's ratio, specific gravity, refractive index, Relative permittivity, Relative permeability.

- **Quantities having units, but no dimensions :**

The following physical quantities possess units but they do not possess any dimensions.

Plane angle, angular displacement, solid angle.

- **Quantities having both units & dimensions :**

The following quantities are examples of such quantities.

Area, Volume, Density, Speed, Velocity, Acceleration, Force, Energy etc.

Physical Constants : These are two types

- i) Dimension less constants (value of these constants will be same in all systems of units):

Numbers, pi, exponential functions are dimension less constants.

- ii) Dimensional constants (value of these constants will be different in different systems of units):

Universal gravitational constant (G), plank's constant (h), Boltzmann's constant (k), Universal gas constant (R), Permittivity of free space (ϵ_0), Permeability of free space (μ_0), Velocity of light (c).

Principle of Homogeneity of dimensions:

The term on both sides of a dimensional equation should have same dimensions. This is called principle of Homogeneity of dimensions.

(or) Every term on both sides of a dimensional equation should have same dimensions. This is called principle of homogeneity of dimensions.

Uses of Dimensional equations :

Dimensional equations are used

- i) to convert units from one system to another,
- ii) to check the correctness of the dimensional equations
- iii) to derive the expressions connecting different physical quantities.

CHECKING THE CORRECTNESS OF PHYSICAL EQUATIONS:

According to the Principle of Homogeneity, if the dimensions of each term on both the sides of equation are same, then the physical quantity will be correct.

The correctness of a physical quantity can be determined by applying dimensions of each quantity

Example 1

To check the correctness of $v = u + at$, using dimensions

Dimensional formula of final velocity $v = [LT^{-1}]$

Dimensional formula of initial velocity $u = [LT^{-1}]$

Dimensional formula of acceleration x time, $at = [LT^{-2} \times T] = [LT^{-1}]$

Dimensions on both sides of each term is the same. Hence, the equation is dimensionally correct.

Example 2

Consider one of the equations of constant acceleration,
$$s = ut + \frac{1}{2} at^2.$$

The equation contains three terms: s , ut and $\frac{1}{2}at^2$.

All three terms must have the same dimensions.

- s : displacement = a unit of length, L
- ut : velocity x time = $LT^{-1} \times T = L$

- $\frac{1}{2}at^2 = \text{acceleration} \times \text{time} = LT^{-2} \times T^2 = L$

All three terms have units of length and hence this equation is dimensionally correct.

•

RESOLUTION OF VECTORS:

Definition:-

- **The process of splitting a vector into various parts or components is called "RESOLUTION OF VECTOR"**
- These parts of a vector may act in different directions and are called "components of vector".

A vector can be resolved into a number of components .Generally there are three components of vector .

Component along X-axis called x-component

Component along Y-axis called Y-component

Component along Z-axis called Z-component

Let us consider only two components x-component & Y-component which are perpendicular to each other. **These components are called rectangular components of vector.**

Method of resolving a vector into its rectangular components:-

Consider a vector \vec{V} acting at a point making an angle θ with positive X-axis. Vector \vec{V} is represented by a line OA. From point A draw a perpendicular AB on X-axis. Suppose OB and BA represents two vectors. Vector \vec{V}_x is parallel to X-axis and vector \vec{V}_y is parallel to Y-axis. Magnitude of these vectors are V_x and V_y respectively. By the method of head to tail we notice that the sum of these vectors is equal to vector \vec{V} . Thus V_x and V_y are the rectangular components of vector \vec{V} .

$V_x = \text{Horizontal component of } \vec{V}$.

$V_y = \text{Vertical component of } \vec{V}$.

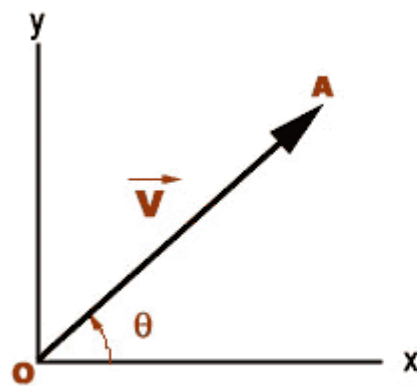

figure 01

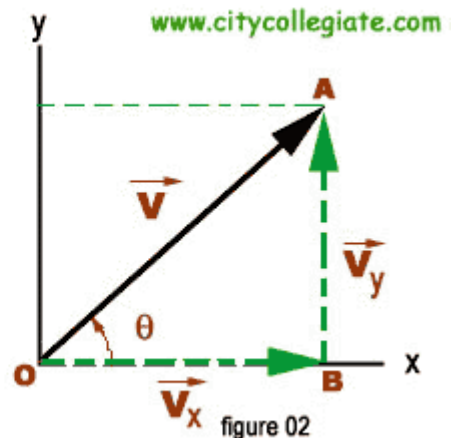

figure 02

MAGNITUDE OF HORIZONTAL COMPONENT:

Consider right angled triangle $\triangle OAB$

$$\cos \theta = \frac{\overline{OB}}{\overline{OA}}$$

$$\overline{OB} = \overline{OA} \cos \theta$$

$$V_x = V \cos \theta$$

MAGNITUDE OF VERTICAL COMPONENT:

Consider right angled triangle

$$\sin \theta = \frac{\overline{AB}}{\overline{OA}}$$

$$\overline{AB} = \overline{OA} \sin \theta$$

$$V_y = V \sin \theta$$

DOT PRODUCT AND CROSS PRODUCT OF VECTORS :-

DOT PRODUCT:

The Dot Product of two vectors \mathbf{A} and \mathbf{B} is

$$\mathbf{A} \cdot \mathbf{B} = \|\mathbf{A}\| \|\mathbf{B}\| \cos \theta, \text{ denoted by}$$

Where θ is the angle between \mathbf{A} and \mathbf{B} .

In particular, if \mathbf{A} and \mathbf{B} are orthogonal, then the angle between them is 90° and

$$\mathbf{A} \cdot \mathbf{B} = 0.$$

At the other extreme, if they are codirectional, then the angle between them is 0° and

$$\mathbf{A} \cdot \mathbf{B} = \|\mathbf{A}\| \|\mathbf{B}\|$$

This implies that the dot product of a vector \mathbf{A} by itself is

$$\mathbf{A} \cdot \mathbf{A} = \|\mathbf{A}\|^2,$$

which gives

$$\|\mathbf{A}\| = \sqrt{\mathbf{A} \cdot \mathbf{A}},$$

Scalar projection and first properties

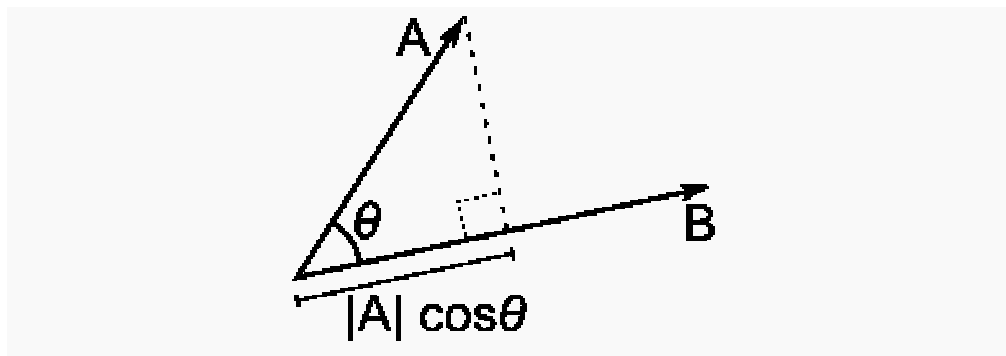

The [scalar projection](#) (or scalar component) of a vector \mathbf{A} in the direction of vector \mathbf{B} is given by

$$A_B = \|\mathbf{A}\| \cos \theta$$

Where θ is the angle between \mathbf{A} and \mathbf{B} .

In terms of the geometric definition of the dot product, this can be rewritten

$$A_B = \mathbf{A} \cdot \hat{\mathbf{B}}$$

Where $\hat{\mathbf{B}} = \mathbf{B}/\|\mathbf{B}\|$ is the [unit vector](#) in the direction of \mathbf{B} .

The dot product is thus characterized geometrically by

$$\mathbf{A} \cdot \mathbf{B} = A_B \|\mathbf{B}\| = B_A \|\mathbf{A}\|.$$

The dot product, defined in this manner, is homogeneous under scaling in each variable, meaning that for any scalar α ,

$$(\alpha \mathbf{A}) \cdot \mathbf{B} = \alpha (\mathbf{A} \cdot \mathbf{B}) = \mathbf{A} \cdot (\alpha \mathbf{B}).$$

The dot product also satisfies a distributive law, meaning that

$$\mathbf{A} \cdot (\mathbf{B} + \mathbf{C}) = \mathbf{A} \cdot \mathbf{B} + \mathbf{A} \cdot \mathbf{C}.$$

$\mathbf{A} \cdot \mathbf{A}$ is never negative and is zero if and only if $\mathbf{A} = \mathbf{0}$.

Properties of scalar product of vectors.

1. Commutative:

$$\mathbf{a} \cdot \mathbf{b} = \mathbf{b} \cdot \mathbf{a}.$$

which follows from the definition (ϑ is the angle between \mathbf{a} and \mathbf{b}):

$$\mathbf{a} \cdot \mathbf{b} = \|\mathbf{a}\| \|\mathbf{b}\| \cos \theta = \|\mathbf{b}\| \|\mathbf{a}\| \cos \theta = \mathbf{b} \cdot \mathbf{a}$$

2. Distributive over vector addition:

$$\mathbf{a} \cdot (\mathbf{b} + \mathbf{c}) = \mathbf{a} \cdot \mathbf{b} + \mathbf{a} \cdot \mathbf{c}.$$

3. Bilinear:

$$\mathbf{a} \cdot (r\mathbf{b} + \mathbf{c}) = r(\mathbf{a} \cdot \mathbf{b}) + (\mathbf{a} \cdot \mathbf{c}).$$

4. Scalar multiplication:

$$(c_1\mathbf{a}) \cdot (c_2\mathbf{b}) = c_1 c_2 (\mathbf{a} \cdot \mathbf{b})$$

5. Orthogonal:

Two non-zero vectors \mathbf{a} and \mathbf{b} are *orthogonal* if and only if $\mathbf{a} \cdot \mathbf{b} = 0$.

CROSS PRODUCT :

The cross product of two vectors \mathbf{a} and \mathbf{b} is defined only in three-dimensional space and is denoted by $\mathbf{a} \times \mathbf{b}$.

The cross product $\mathbf{a} \times \mathbf{b}$ is defined as a vector \mathbf{c} that is perpendicular to both \mathbf{a} and \mathbf{b} , with a direction given by the right-hand rule and a magnitude equal to the area of the parallelogram that the vectors span.

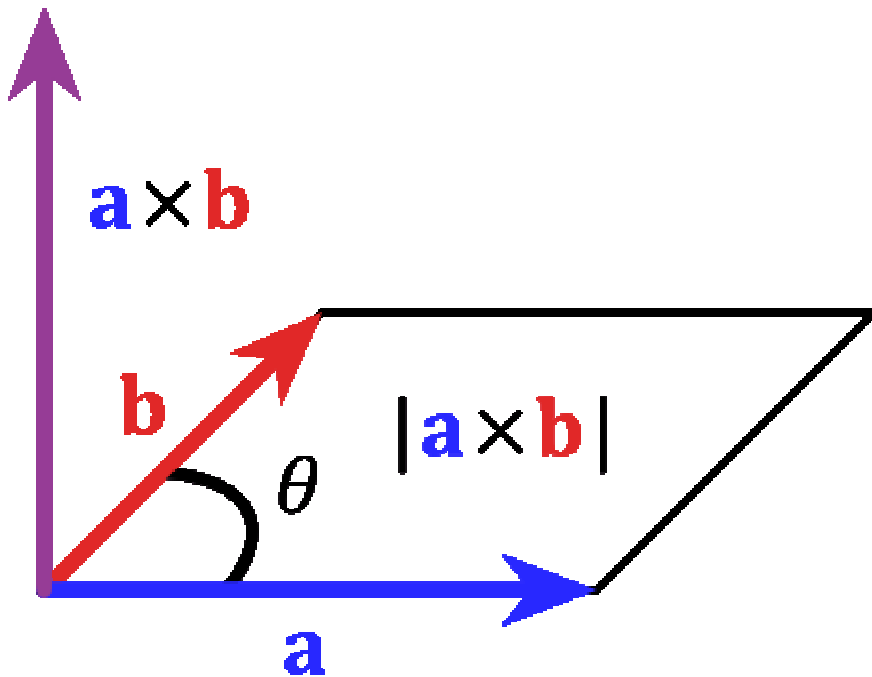

The cross product is defined by the formula

$$\mathbf{a} \times \mathbf{b} = \|\mathbf{a}\| \|\mathbf{b}\| \sin \theta \mathbf{n}$$

where ϑ is the angle between **a** and **b** in the plane containing them (hence, it is between 0° and 180°),

$\|\mathbf{a}\|$ and $\|\mathbf{b}\|$ are the magnitudes of vectors **a** and **b**,

and **n** is a unit vector perpendicular to the plane containing **a** and **b** in the direction given by the right-hand rule (illustrated).

If the vectors **a** and **b** are parallel (i.e., the angle ϑ between them is either 0° or 180°), by the above formula, the cross product of **a** and **b** is the zero vector **0**.

By convention, the direction of the vector **n** is given by the right-hand rule, where one simply points the forefinger of the right hand in the direction of **a** and the middle finger in the direction of **b**. Then, the vector **n** is coming out of the thumb

Using this rule implies that the cross-product is anti-commutative, i.e., $\mathbf{b} \times \mathbf{a} = -(\mathbf{a} \times \mathbf{b})$.

Pointing the forefinger toward \mathbf{b} first, and then pointing the middle finger toward \mathbf{a} , the thumb will be forced in the opposite direction, reversing the sign of the product vector.

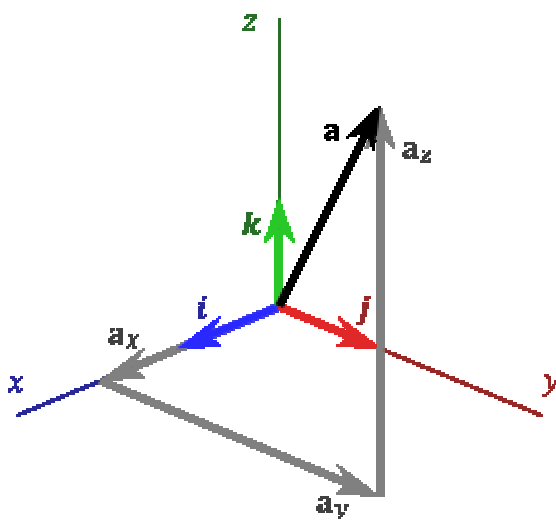
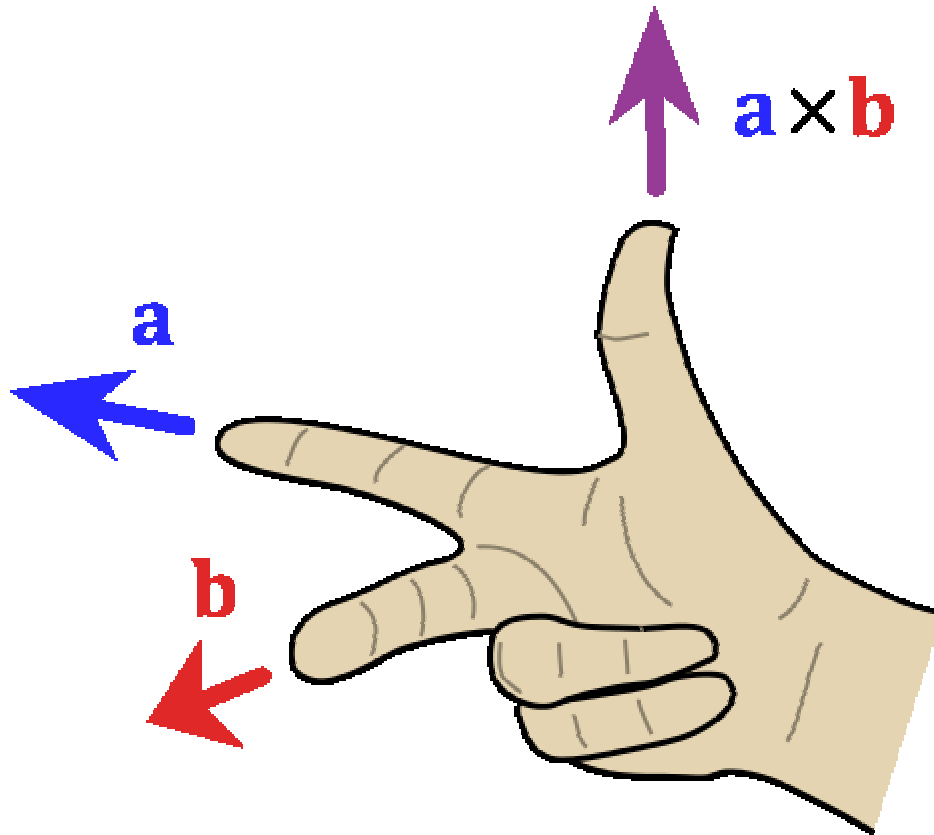

The standard basis vectors \mathbf{i} , \mathbf{j} , and \mathbf{k} satisfy the following equalities:

$$\mathbf{i} = \mathbf{j} \times \mathbf{k}$$

$$\mathbf{j} = \mathbf{k} \times \mathbf{i}$$

$$\mathbf{k} = \mathbf{i} \times \mathbf{j}$$

which imply, by the [anticommutativity](#) of the cross product, that

$$\mathbf{k} \times \mathbf{j} = -\mathbf{i}$$

$$\mathbf{i} \times \mathbf{k} = -\mathbf{j}$$

$$\mathbf{j} \times \mathbf{i} = -\mathbf{k}$$

The definition of the cross product also implies that

$$\mathbf{i} \times \mathbf{i} = \mathbf{j} \times \mathbf{j} = \mathbf{k} \times \mathbf{k} = \mathbf{0} \text{ (the [zero vector](#))}.$$

$$\mathbf{u} = u_1\mathbf{i} + u_2\mathbf{j} + u_3\mathbf{k}$$

$$\mathbf{v} = v_1\mathbf{i} + v_2\mathbf{j} + v_3\mathbf{k}$$

Their cross product $\mathbf{u} \times \mathbf{v}$ can be expanded using [distributivity](#):

$$\begin{aligned}\mathbf{u} \times \mathbf{v} &= (u_1\mathbf{i} + u_2\mathbf{j} + u_3\mathbf{k}) \times (v_1\mathbf{i} + v_2\mathbf{j} + v_3\mathbf{k}) \\ &= u_1v_1(\mathbf{i} \times \mathbf{i}) + u_1v_2(\mathbf{i} \times \mathbf{j}) + u_1v_3(\mathbf{i} \times \mathbf{k}) \\ &\quad + u_2v_1(\mathbf{j} \times \mathbf{i}) + u_2v_2(\mathbf{j} \times \mathbf{j}) + u_2v_3(\mathbf{j} \times \mathbf{k}) \\ &\quad + u_3v_1(\mathbf{k} \times \mathbf{i}) + u_3v_2(\mathbf{k} \times \mathbf{j}) + u_3v_3(\mathbf{k} \times \mathbf{k})\end{aligned}$$

$$\begin{aligned}\mathbf{u} \times \mathbf{v} &= u_1v_1\mathbf{0} + u_1v_2\mathbf{k} - u_1v_3\mathbf{j} \\ &\quad - u_2v_1\mathbf{k} - u_2v_2\mathbf{0} + u_2v_3\mathbf{i} \\ &\quad + u_3v_1\mathbf{j} - u_3v_2\mathbf{i} - u_3v_3\mathbf{0} \\ &= (u_2v_3 - u_3v_2)\mathbf{i} + (u_3v_1 - u_1v_3)\mathbf{j} + (u_1v_2 - u_2v_1)\mathbf{k}.\end{aligned}$$

$$s_1 = u_2v_3 - u_3v_2$$

$$s_2 = u_3v_1 - u_1v_3$$

$$s_3 = u_1v_2 - u_2v_1$$

$$\mathbf{u} \times \mathbf{v} = \begin{vmatrix} u_2 & u_3 \\ v_2 & v_3 \end{vmatrix} \mathbf{i} - \begin{vmatrix} u_1 & u_3 \\ v_1 & v_3 \end{vmatrix} \mathbf{j} + \begin{vmatrix} u_1 & u_2 \\ v_1 & v_2 \end{vmatrix} \mathbf{k}$$

The [magnitude](#) of the cross product can be interpreted as the positive [area](#) of the [parallelogram](#) having \mathbf{a} and \mathbf{b} as sides

$$A = \|\mathbf{a} \times \mathbf{b}\| = \|\mathbf{a}\| \|\mathbf{b}\| \sin \theta.$$

PROPERTIES OF CROSS PRODUCT:

- If the cross product of two vectors is the zero vector, ($\mathbf{a} \times \mathbf{b} = \mathbf{0}$), then either of them is the zero vector, ($\mathbf{a} = \mathbf{0}$, or $\mathbf{b} = \mathbf{0}$) or both of them are zero vectors, ($\mathbf{a} = \mathbf{b} = \mathbf{0}$), or else they are parallel or antiparallel, ($\mathbf{a} \parallel \mathbf{b}$), so that the sine of the angle between them is zero, ($\vartheta = 0^\circ$ or $\vartheta = 180^\circ$ and $\sin \vartheta = 0$).

- The self cross product of a vector is the zero vector, i.e., $\mathbf{a} \times \mathbf{a} = \mathbf{0}$.

- The cross product is anticommutative,

$$\mathbf{a} \times \mathbf{b} = -\mathbf{b} \times \mathbf{a},$$

- distributive over addition,
 $\mathbf{a} \times (\mathbf{b} + \mathbf{c}) = (\mathbf{a} \times \mathbf{b}) + (\mathbf{a} \times \mathbf{c}),$

- and compatible with scalar multiplication so that
 $(r\mathbf{a}) \times \mathbf{b} = \mathbf{a} \times (r\mathbf{b}) = r(\mathbf{a} \times \mathbf{b}).$

UNIT-2

CURVILINEAR MOTION & KINEMATICS

PROJECTILE MOTION :-

Definition & Concept:-

- A body projected into space and is no longer provided with any fuel is called projectile and motion of the body is said to be projectile motion.
- A projectile can be thrown into all possible directions into the 3D space, which is categorized into three parts,
 1. along vertical direction.
 2. along horizontal direction.
 - along any direction making an angle of θ with horizontal.
- When the projectile is thrown towards the gravitational force of earth , acceleration of the object is equal the value of acceleration due to gravity. When it is thrown opposite to force of gravity, acceleration of the object is negative of the value of acceleration due to gravity.
- When the projectile is thrown in any direction making an angle θ with the horizontal, its motion can be consider as the resultant of horizontal and vertical motion.

Examples :-

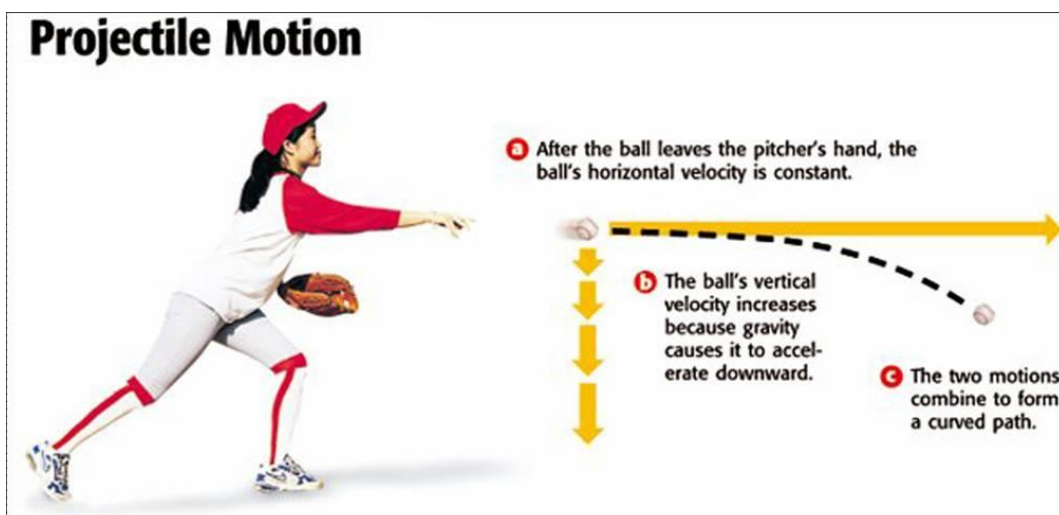

Projectile Motion

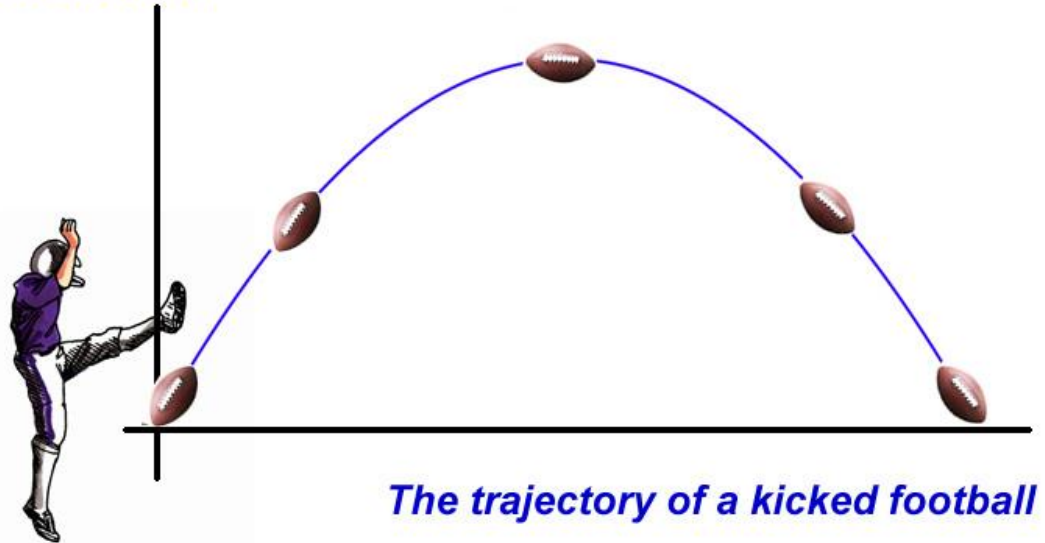

Projectile is a body thrown with an initial velocity in the vertical plane and then it moves in two dimensions under the action of gravity alone without being propelled by any engine or fuel. Its motion is called projectile motion. The path of a projectile is called its trajectory.

Examples:

1. A packet released from an airplane in flight.
2. A golf ball in flight.
3. A bullet fired from a rifle.
4. A jet of water from a hole near the bottom of a water tank.

A body can be projected in three ways :

- i. **Vertical Projection** – When the body is given an initial velocity in the Vertical direction only.
- ii. **Horizontal projection**-When the body is given an initial velocity in the horizontal direction only.
- iii. **Angular projection**-When the body is thrown with an initial velocity at an angle to the horizontal direction.

Let us consider all the three cases separately neglecting the effect of air resistance.

Let us take x-axis along the horizontal direction and y-axis along the vertical direction.

Case 1- **Vertical Projection** :

A body is thrown from point A with an initial velocity u along the vertical direction. Due to the action of acceleration due to gravity acting downwards, the velocity decreases and becomes zero at B.

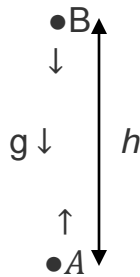

Along x-axis	Along y-axis
1. Component of initial velocity along x-axis. $u_x=0$	1. Component of initial velocity along y-axis. $u_y=u$
2. Acceleration along x-axis $a_x=0$ (Because no force is acting along the horizontal direction)	2. Acceleration along y-axis $a_y=g=9.8\text{m/s}^2$ It is directed downwards
3. Component of velocity along the x-axis at any instant t . $v_x=0$	3. Component of velocity along the y-axis at any instant t . $v_y=u_y + a_y t$ $=u + gt$ $v_y= u + gt$
4. The displacement along x-axis at any instant t $x=u_x t + (1/2) a_x t^2$ $x=0$	4. The displacement along y-axis at any instant t $y= u_y t + (1/2) a_y t^2$ $y= ut - (1/2) gt^2$

velocity at any instant of time t

We know , at any instant **t**

$$v_x= 0$$

$$v_y= u + gt$$

$$v= (v_x^2 + v_y^2)^{1/2} = u + gt$$

Time of flight (T):

It is the total time for which the projectile is in flight (from A to B and back to A in the diagram above)

To find T we will find the time of ascent and descent

Time of ascent:-

$$v_y = u + gt$$

At B, $v_y = 0$, $g = -g$ (as the body is going upward)

$$0 = u - gt$$

$$t = u/g$$

Hence, the time of flight = T = time of ascent + time of descent =

$$2t = 2u/g$$

Range (R) :

It is the horizontal distance covered during the time of flight T

Since, $u_x = 0$, the horizontal distance covered during the time of flight T = 0

Case 2-- Horizontal Projection

A body is thrown with an initial velocity u along the horizontal direction.

The motion along x and y axis will be considered separately.

Let us take the starting point to be at the origin.

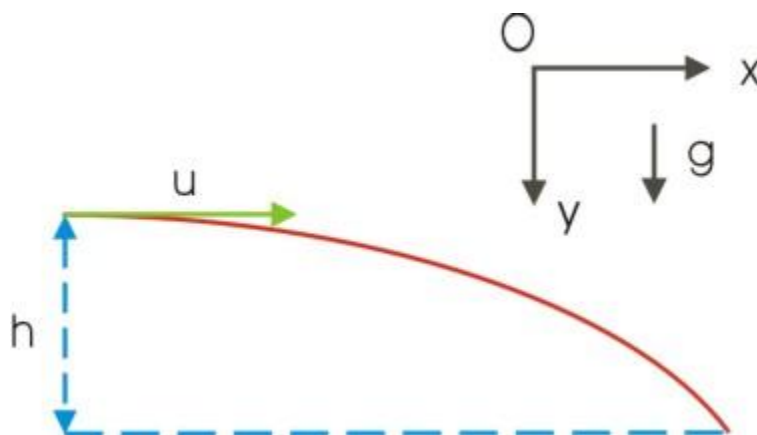

Along x-axis	Along y-axis
1. Component of initial velocity along x-axis. $u_x = u$	1. Component of initial velocity along y-axis. $u_y = 0$
2. Acceleration along x-axis $a_x = 0$ (Because no force is acting along the horizontal direction)	2. Acceleration along y-axis $a_y = g = 9.8 \text{ m/s}^2$ It is directed downwards.
3. Component of velocity along the x-axis at any instant t . $v_x = u_x + a_x t$ $= u + 0$ $v_x = u$ This means that the horizontal component of velocity does not change throughout the projectile motion.	3. Component of velocity along the y-axis at any instant t . $v_y = u_y + a_y t$ $= 0 + gt$ $v_y = gt$
4. The displacement along x-axis at any instant t $x = u_x t + (1/2) a_x t^2$ $x = u_x t + 0$ $x = u t$	4. The displacement along y-axis at any instant t $y = u_y t + (1/2) a_y t^2$ $y = 0 + (1/2) a_y t^2$ $y = (1/2) g t^2$

Equation of a trajectory (path of a projectile)

We know, $x = ut$

$$t = x/u$$

Also, $y = (1/2)gt^2$

Substituting for t we get

$$y = (1/2)g(x/u)^2$$

$$y = (1/2)(g/u^2)x^2$$

$$y = kx^2 \text{ where } k = g/(2u^2)$$

This is the equation of a parabola which is symmetric about the y-axis. Thus, the path of projectile, projected horizontally from a height above the ground is a parabola.

velocity at any instant of time t

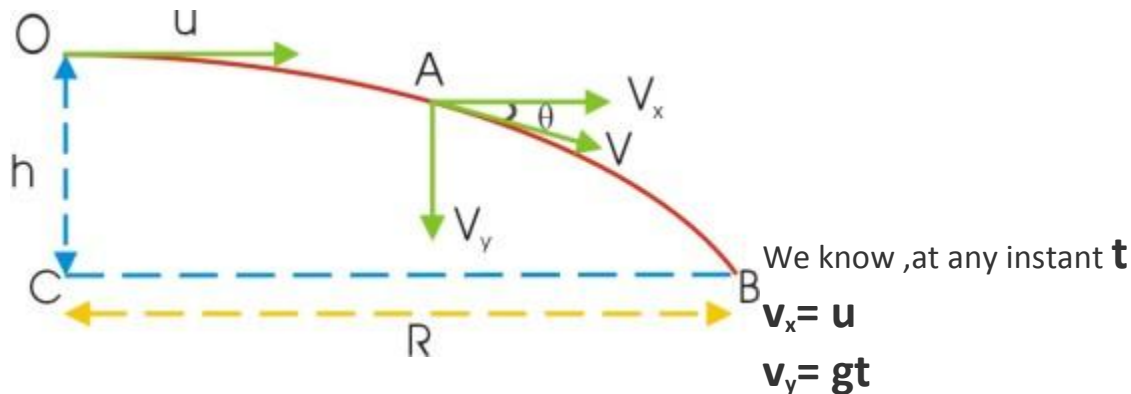

$$v = (v_x^2 + v_y^2)^{1/2} = [u^2 + (gt)^2]^{1/2}$$

Time of flight (T):

It is the total time for which the projectile is in flight (from O to B in the diagram above)

To find T we will find the time for vertical fall

$$\text{From } y = u_y t + (1/2) g t^2$$

At the point O, $y = h$, $t = T$

$$h = 0 + (1/2) g t^2$$

$$T = (2h/g)^{1/2}$$

Range (R) :

It is the horizontal distance covered during the time of flight T.

$$\text{From } x = ut$$

When $t = T$, $x = R$

$$R = uT$$

$$R = u(2h/g)^{1/2}$$

Case 3: Angular Projection:-

Let us consider the case when the object is projected with an initial velocity u at an angle ϕ to the horizontal direction.

Let air resistance is negligible .

Since the body first goes up and then comes down after reaching the highest point , we will use the Cartesian convention for signs of different physical quantities. **The acceleration due to gravity 'g' will be negative as it acts downwards.**

Here the motion of body can be separated into horizontal motion (motion along x-axis) and vertical motion (motion along y-axis).

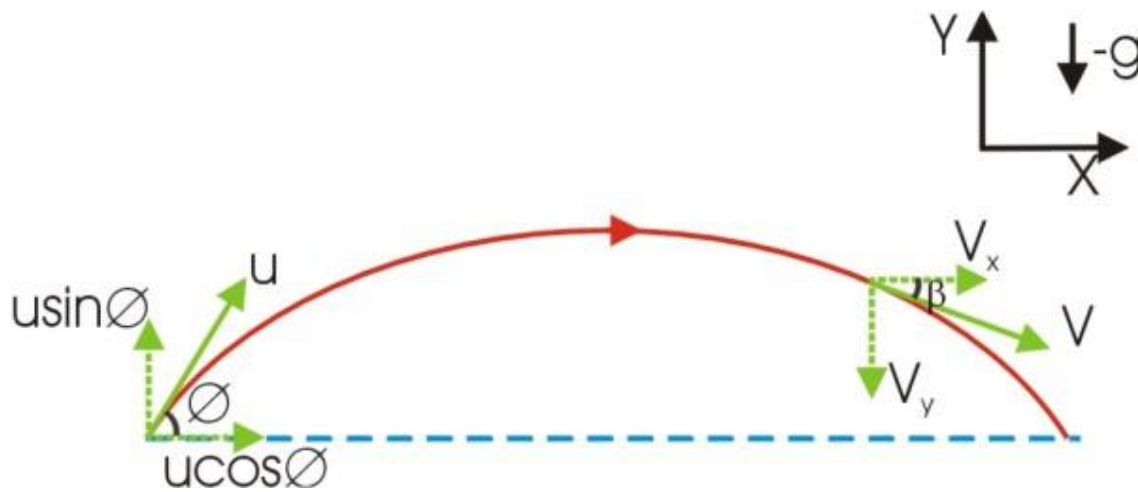

X axis	Y axis
1. Component of initial velocity along x-axis. $u_x = u \cos \Phi$	1. Component of initial velocity along y-axis. $u_y = u \sin \Phi$
2. Acceleration along x-axis $a_x = 0$ (Because no force is acting along the horizontal direction)	2. Acceleration along y-axis $a_y = -g = -9.8 \text{ m/s}^2$ (g is negative as it is acting in the downward direction)
3. Component of velocity along the x-axis at any instant t . $v_x = u_x + a_x t$ $= u \cos \Phi + 0 = u \cos \Phi$ $v_x = u \cos \Phi$ This means that the horizontal component of velocity does not change throughout the projectile motion.	3. Component of velocity along the y-axis at any instant t . $v_y = u_y + a_y t$ $v_y = u \sin \Phi - gt$
4. The displacement along x-axis at any instant t $x = u_x t + (1/2) a_x t^2$ $x = u \cos \Phi \cdot t$	4. The displacement along y-axis at any instant t $y = u_y t + (1/2) a_y t^2$ $y = u \sin \Phi \cdot t - (1/2) g t^2$

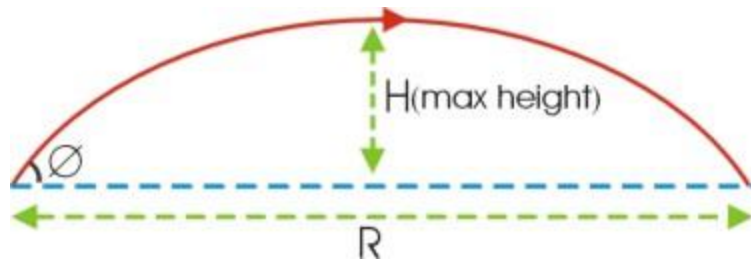

Equation of Trajectory (Path of projectile)

At any instant t

$$x = u \cos \Phi \cdot t$$

$$t = x / (u \cos \Phi)$$

$$\text{Also, } y = u \sin \Phi \cdot t - (1/2)gt^2$$

Substituting for t

$$y = u \sin \Phi \cdot x / (u \cos \Phi) - (1/2)g[x / (u \cos \Phi)]^2$$

$$y = x \cdot \tan \Phi - [(1/2)g \cdot \sec^2 \Phi \cdot x^2] / u^2$$

This equation is of the form $y = ax + bx^2$ where 'a' and 'b' are constants. This is the equation of a parabola. Thus, the path of a projectile is a parabola.

velocity of the body at any instant of time t

$$v_x = u \cos \Phi$$

$$v_y = u \sin \Phi - gt$$

$$v = (v_x^2 + v_y^2)^{1/2}$$

$$= (u^2 \cos^2 \Phi + u^2 \sin^2 \Phi - 2 u \sin \Phi gt + g^2 t^2)$$

$$= u^2 - 2 u \sin \Phi gt + g^2 t^2$$

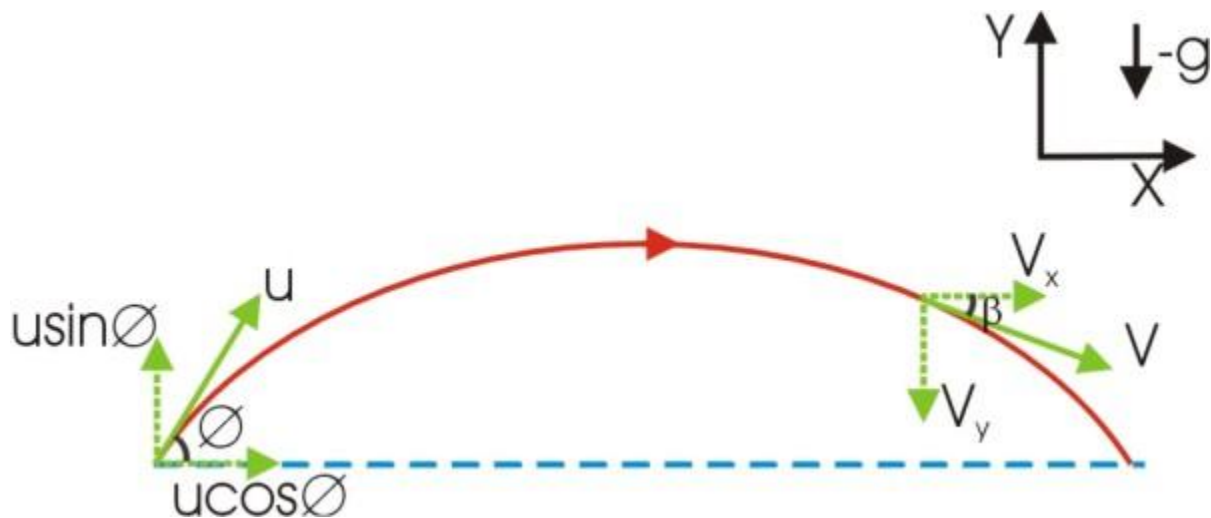

Time of flight T

It is the time taken by the projectile to come back to the same level from which it was projected .i.e. It is the sum of time of ascent (rise) and time of descent (fall).

Angular Projectile motion is symmetrical about the highest point.

Hence, the time of ascent (rise) = time of descent (fall).

Time of ascent :-

Let, t = the time taken by the projectile to reach the highest point

.At the highest point, the vertical component of velocity $v_y = 0$

Applying the formula, $v_y = u \sin \Phi - gt$

$$0 = u \sin \Phi - gt \Rightarrow t = u \sin \Phi / g$$

$$\text{Hence, } T = 2t = 2u \sin \Phi / g$$

Maximum height H

Equation for vertical distance (y component)

$$y = u_y t - (1/2)gt^2$$

$$\text{At, } t = T/2, y = H$$

$$H = u \sin \Phi \cdot T/2 - (1/2)g(T/2)^2$$

substituting T

$$H = u \sin \Phi \cdot u \sin \Phi / g - (1/2)g(u \sin \Phi / g)^2$$

$$= (u^2 \sin^2 \Phi) / g - (u^2 \sin^2 \Phi) / 2g$$

$$H = (u^2 \sin^2 \Phi) / 2g$$

Range R

Range is the total horizontal distance covered during the time of flight.

From equation for horizontal motion, $x = u_x t$

When $t = T$, $x = R$

$$R = u_x T = u \cos \Phi \cdot 2u \sin \Phi / g$$

$$= u^2 2 \sin \Phi \cos \Phi / g = u^2 \sin 2\Phi / g \text{ using, } 2 \sin \Phi \cos \Phi = \sin 2\Phi,$$

$$R = (u^2 \sin 2\Phi) / g$$

Condition for maximum horizontal range :-

The horizontal range depends upon the velocity of projection u and the angle of projection Φ . For a given value of u , the range will be maximum when $\sin 2\Phi$ will be maximum.

Hence, $\sin 2\Phi = 1 \Rightarrow \Phi = 45^\circ$, this is the condition for maximum range.

$$R_{\max} = u^2 / g$$

FRICTION-

Definition :- Frictional force is a force that resists movement between two objects. If friction is limiting, it is providing the maximum possible force it can.

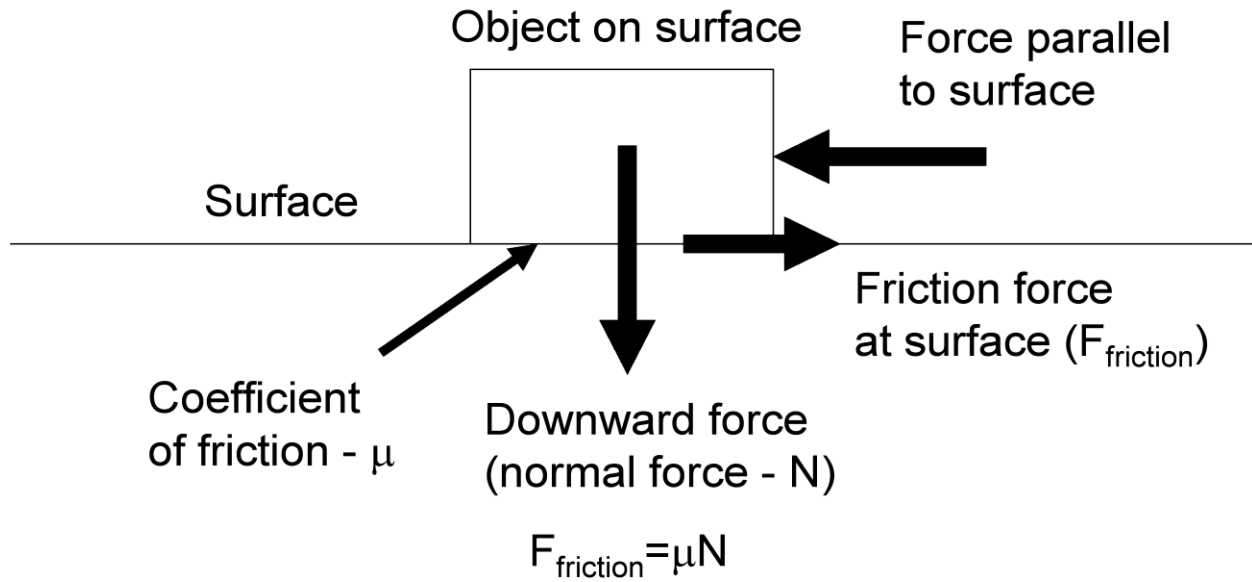
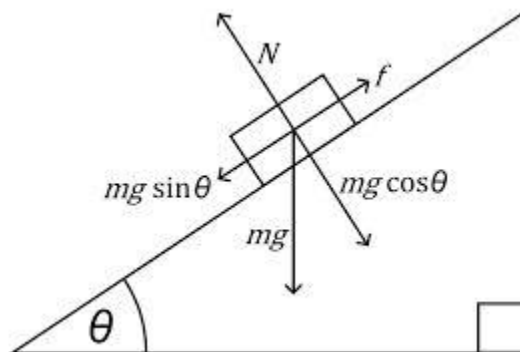

Figure 1 – Basic Definitions of the Coefficient of Friction



Types of Friction :-

There are four types of friction namely

1. Static friction
2. Kinetic friction
3. Rolling friction
4. Fluid friction

Concept Maps
www.eduvictors.com

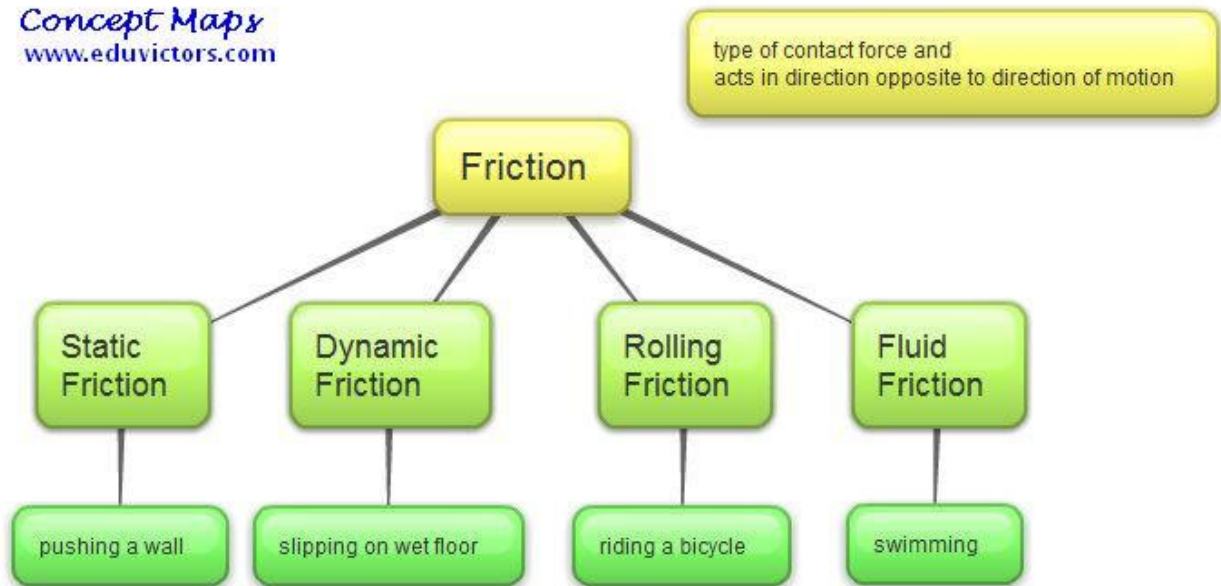

Static Friction:-

The resistance encountered by a body in static condition while tending to move under the action of an external force is called static friction (f). Static friction is equal and opposite to the applied force.

Static friction comes into play when a body is forced to move along a surface but movement does not start. The magnitude of static friction remains equal to the applied external force and the direction is always opposite to the direction of motion. The magnitude of static friction depends upon μ_s (coefficient of static friction) and N (net normal reaction of the body).

Example:- Consider a block 'B' which is resting on a horizontal table. Let a small pan be attached to the block by means of a horizontal thread passing over a smooth frictionless pulley. Initially when weight in the pan is zero, the body does not move because the applied force due to the weight in the pan is zero, the body does not move because the applied force due to the weight of the pan becomes equal and opposite to the force of friction between the table and the body. When the weight in the pan is increased the body may still be static. The body does not move because the

resultant force on the body is zero. The frictional force is equal in magnitude and opposite in direction to the applied force 'P' and is tangential between the two surfaces.

When the applied force (P) is increased the frictional force also increases equally until the body starts moving. When it is about to slide on the table, the static friction reaches a maximum value. Any further increase in the applied force makes the body slide on the table.

The maximum value of static friction is called Limiting friction.

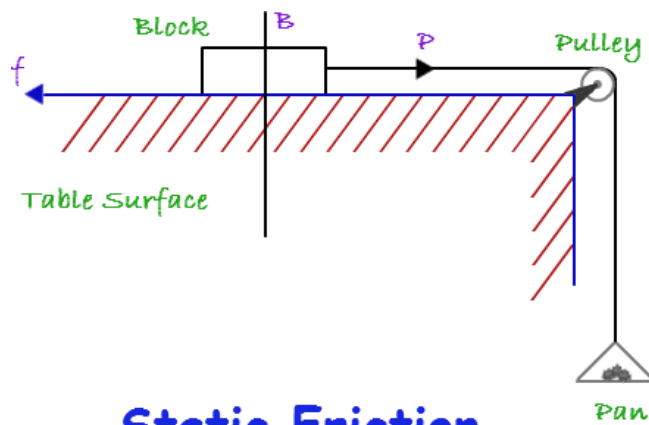

Static Friction

Dynamic or Kinetic Friction

The resistance encountered by a sliding body on a surface is known as kinetic friction or dynamic friction or sliding friction

Kinetic friction denoted as μ_k comes into play when a body just starts moving along a surface. When external applied force is sufficient to move a body along a surface then the force which opposes this motion is called as kinetic frictional force.

$$\text{Magnitude of kinetic frictional force } f_k = \mu_k N$$

Where μ_k is coefficient of kinetic frictional force and N is the net normal reaction on the body. The magnitude of kinetic frictional force is always less than magnitude of static frictional force. When value of applied net external force F is more than f_k then body moves with a net acceleration and when these forces are equal then body moves with a constant velocity.

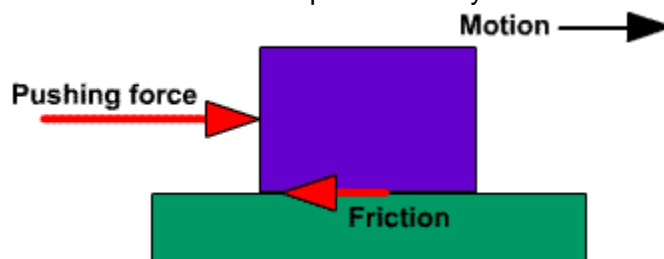

Rolling Friction

If a wheel or a cylinder or a spherical body like a marble rolls on a horizontal surface, the speed of rolling gradually decreases and it finally stops. The resistance encountered by a rolling body on the surface is known as Rolling friction

Rolling frictional force is a force that slows down the motion of a rolling object. Basically it is a combination of various types of frictional forces at point of contact of wheel and ground or surface. When a hard object moves along a hard surface then static and molecular friction force retards its motion. When soft object moves over a hard surface then its distortion makes it slow down.

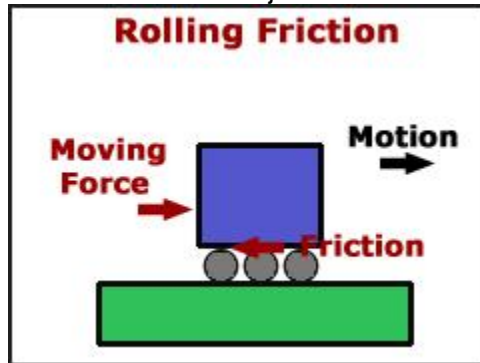

Fluid Friction

When a body moves in a fluid or in air then there exists a resistive force which slows down the motion of the body, known as fluid frictional force.

A freely falling skydiver feels a drag force due to air which acts in the upward direction or in a direction opposite to skydiver's motion. The magnitude of this drag force increases with increment in the downward velocity of skydiver. At a particular point of time the value of this drag force becomes equal to the driving force and skydiver falls with a constant velocity.



FORCE OF LIMITING FRICTION :-

when a horizontal force is applied to a static body to move the same, a frictional force equal to the applied force develops in the opposite direction resisting the motion. As long as the body does not move, this force is called static frictional force. Now if the applied force is increased, the frictional force in the opposite direction increases proportionately until it reaches the limit after which if the applied force is increased, the body starts moving. This threshold force is called static or limiting force of friction.

LAWS OF LIMITING FRICTION

- The direction of force of friction is always opposite to the direction of motion.
- Force of friction depends upon the nature and state of polish of the surfaces in contact.
- It acts tangentially to the interface between the two surfaces.
- Magnitude of limiting friction “F” is directly proportional to the normal reaction “R” between the two surfaces in contact.

$$F \propto R$$

$$\Rightarrow \mathbf{F} = \boldsymbol{\mu} \mathbf{R}$$

μ = The proportionality constant called the **COEFFICIENT OF FRICTION**

- Magnitude of limiting friction between two surfaces is independent of area and shape of surfaces in contact so long as the normal reaction remains the same.

Methods to reduce Friction:-

Introduction:-

Friction is a necessary evil. In some situations, it plays a positive role whereas in others, it is not needed. The net efficiency of any machine depends on the amount of friction present in that machine, because a large part of the input energy of all machines is wasted in overcoming friction between its various parts, and thus the total output from the machine decreases.

There is thus a need to find ways to decrease friction in order to make machines more efficient and to increase their life time. These ways of decreasing friction can be applied in different parts of machines according to the function of that part, and thus a more efficient machine is constructed.

The following techniques are different ways to decrease friction used widely:

- **USE OF LUBRICANTS**

The use of lubricants like oil and grease helps to reduce friction by forming a thin film between different parts of a machine. This film covers up the scratches and lumps present on the surfaces of different parts and thus makes the surface more even than before. This reduces interlocking between the two surfaces, and hence the parts of the machine run smoothly.

- **USE OF BALL BEARINGS**

Two moving surfaces in a machine are fixed by placing small balls or rollers made out of steel in between them. This way, the moving parts avoid direct contact and sliding friction is changed to rolling friction. Rolling friction is less than sliding friction, thereby decreasing the amount of friction in the machine.

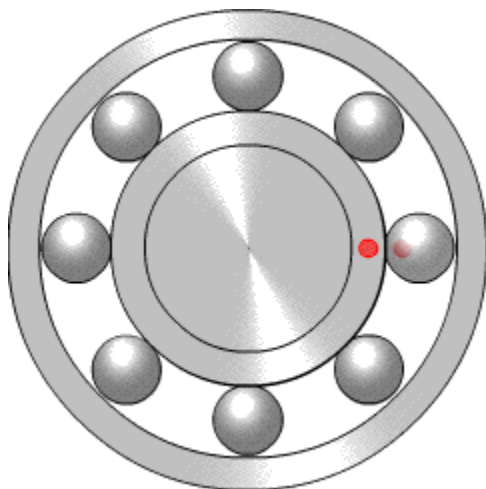

- **BY POLISHING**

The unevenness of surfaces can be reduced by polishing them. This will reduce the interlocking between surfaces in contact thus reducing friction.

- **USING SOFT, FINE POWDER**

Soft, fine powder like talcum powder and graphite powder also helps in filling in the microscopic scratches and grooves on a surface and thus make it more even and less prone to interlocking with other surfaces. Thus, friction is reduced.

- **STREAMLINING**

Streamlining is the process of making a machine's shape such, that avoids resistance from air and water molecules while moving. For example airplanes have a streamlined shape which reduces friction between air molecules while flying. This is because fluids move with less friction over a streamlined surface, and the object moves forward as if cutting through them. The following diagram shows a streamlined and a blunt body:-



- **Use of correct combination of surfaces in contact:-**

Use of alloys on moving and sliding parts reduces friction because alloys have a low coefficient of friction.

UNIT-3

GRAVITATION,

PLANETARY

MOTION

&

SIMPLE HARMONIC

MOTION

KEPLER'S LAWS OF PLANETARY MOTION- :

Kepler's 1st Law (Law of elliptical Orbits) :

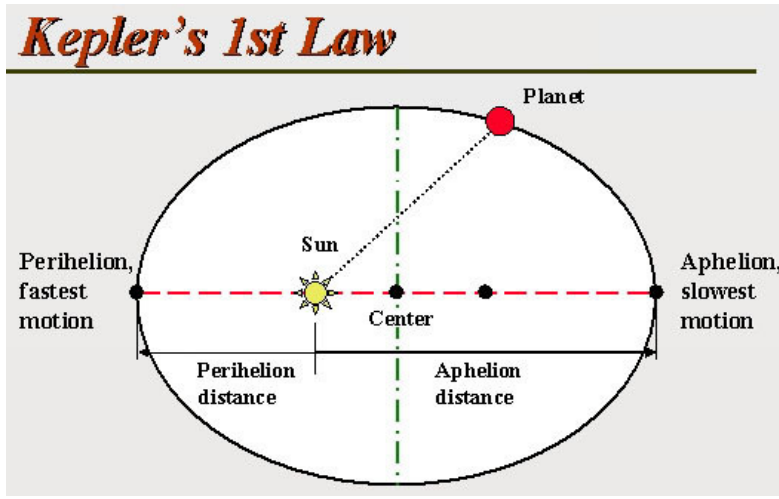

A planet moves around the sun in an elliptical orbit with the sun situated at one of its *focii*.

Since the focus of an ellipse is *not equidistant* from the point of orbit, the distance of planet varies from certain *minimum* to *maximum* value. Here, the rotation is the reason of *season change* from summer to winter and repetition of same year after year.

Kepler's 2nd Law (Law of Areal Velocity) :

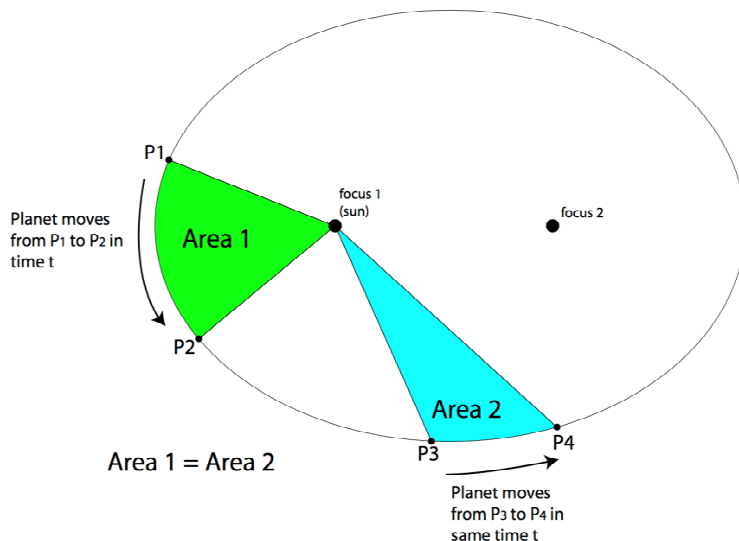

A planet moves in such a way that its areal velocity always remains constant.

Areal velocity : The line joining the planet with the sun sweeps equal area in equal interval of time.

According to the law :

$$\begin{aligned} \text{Area (A}_1\text{)} &= \text{area (A}_2\text{)} \\ \Rightarrow P_1.P_2 \times SP_1 &= SP_3 \times P_3.P_4 \end{aligned}$$

From the figure it is clear that :

SP_1 is less than SP_3

$$SP_1 < SP_3$$

Therefore ;

$$P_1 . P_2 > P_3 . P_4$$

Since the areal velocity is constant,

the time taken by planet to move from P_1 to P_2 = the time taken by planet to move from P_3 to P_4 .

Since $P_1 . P_2 > P_3 . P_4$, the planet moves faster when travels from P_1 to P_2 and moves slower when travels from P_3 to P_4 .

Thus the orbital velocity of planet *is not uniform*. It is **maximum** when the planet is **nearest to sun** (summer season) and **minimum** when the planet is **away from** the sun at a maximum distance (winter season).

Kepler's 3rd Law (Law of Time Period) :

A Planet moves round the sun in such a way that the square of its period is proportional to the cube of semi- major axis of its elliptical orbit.

$$T^2 \propto R^3$$

If T_1 and T_2 are the time periods of two planets having semi-major axis R_1 and R_2 , then,

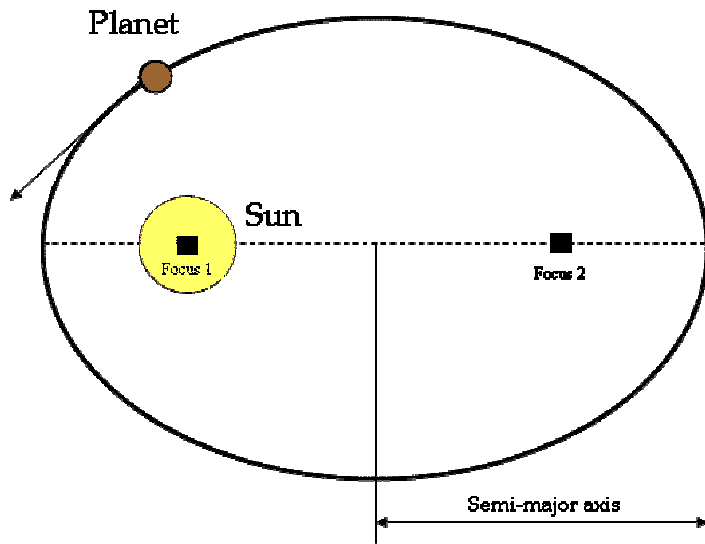
$$\frac{T_1^2}{R_1^3} = \frac{T_2^2}{R_2^3}$$

Acceleration due to Gravity 'g'

Bodies allowed to fall freely are found to fall at the same rate irrespective of their masses (air resistance being negligible).

The velocity of a freely falling body increased at a steady rate i.e., the body moves with acceleration. This acceleration is called acceleration due to gravity - 'g'.

We know,

$$F = mg \text{ ----- (1)}$$

$$F = \frac{GMm}{r^2} \text{ ----- (2)}$$

Where F is the force, m is the mass of the body, g is the acceleration due to gravity, M is the mass of the Earth, R is the radius of the Earth and G is the gravitational constant.

From equations (1) and (2),

$$mg = \frac{GMm}{R^2} \Rightarrow g = \frac{GM}{R^2} \text{ ----- (3)}$$

Variation of acceleration due to gravity (g):-

' g ' varies with

- (a) altitude
- (b) depth
- (c) latitude

(a) Variation of ' g ' with altitude :-

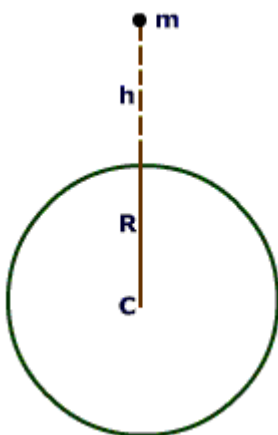

Let a body of mass m be placed on the surface of the Earth, whose mass is M and radius is R .

From equation (3)

$$g = \frac{GM}{R^2}$$

Let the body be now placed at a height h above the Earth's surface. Let the acceleration due to gravity at that position be g' .

$$\text{Then, } g' = \frac{GM}{(R+h)^2} \text{ ----- (4)}$$

For comparison, the ratio between g' and g is taken

$$\frac{g'}{g} = \frac{GM}{(R+h)^2} \div \frac{GM}{R^2}$$

$$g' = g \left(\frac{R}{R+h} \right)^2$$

$$= g \frac{R^2}{R^2} \left(\frac{1}{1 + \frac{h}{R}} \right)^2$$

$$= g \left(1 + \frac{h}{R} \right)^{-2}$$

Applying Binomial Expansion,

$$\left(1 + \frac{h}{R} \right)^{-2} = 1 - 2\frac{h}{R} + 3\frac{h^2}{R^2} - 4\frac{h^3}{R^3} + 5\frac{h^4}{R^4}$$

h is assumed to be very small when compared to radius R of the Earth.

$\therefore \frac{h}{R}$ is small and $\left(\frac{h}{R}\right)^2, \left(\frac{h}{R}\right)^3, \left(\frac{h}{R}\right)^4$ are very, very small

Hence, they can be neglected

$$\therefore \left(1 + \frac{h}{R}\right)^{-2} \approx 1 - \frac{2h}{R}$$

$$g' = g \left(1 - \frac{2h}{R}\right) \text{----- (5)}$$

Hence, $g' < g$

This shows that acceleration due to gravity decreases with increase in altitude.

b) Variation of 'g' with depth

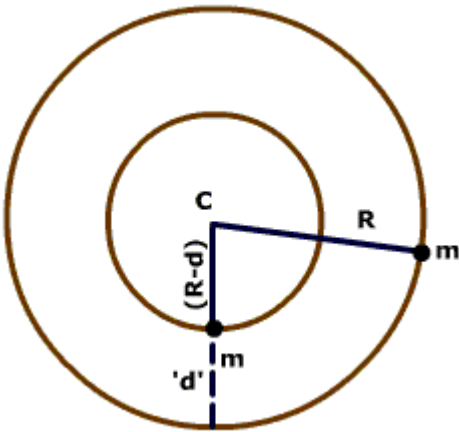

Let us consider a body of mass m , lying on the surface of the Earth of radius R and mass M . Let g be the acceleration due to gravity at that place.

$$\therefore g = \frac{GM}{R^2}$$

Let the body be taken to a depth d from the surface of the Earth. Then, the force due to gravity acting on this body is only due to the sphere of radius $(R - d)$.

Let g' is the acceleration due to gravity at depth ' d '

$$\text{Then } g' = \frac{GM'}{(R - d)^2}$$

Let the Earth be of uniform density and its shape be a perfect sphere.

For a sphere, the volume is given by,

$$V_{\text{sphere}} = \frac{4}{3} \pi r^3 \text{ when } r = \text{radius of sphere}$$

$$M = \text{Mass of earth} = \text{Volume of earth} \times \text{Density of earth} = \frac{4}{3} \times R^3 \times$$

$$M' = \text{Mass of earth of radius } (R-d) = \frac{4}{3} (R-d)^3 \times$$

Applying the value of M' and R' ,

$$g' = \frac{G M'}{R'^2} = \frac{G \left(\frac{4}{3} \times (R-d)^3 \times \right)}{(R-d)^2} \times \dots\dots\dots(6)$$

$$g = \frac{G M}{R^2} = \frac{G \times \frac{4}{3} \times R^3 \times}{R^2} \dots\dots\dots(7)$$

Comparing g' and g ,

$$\frac{g'}{g} = \frac{\left(\frac{4}{3} \times (R-d)^3 \times \right) \times \left(\frac{4}{3} \times R^3 \times \right)}{\left(\frac{4}{3} \times R^3 \times \right) \times \left(\frac{4}{3} \times R^3 \times \right)}$$

$$= \frac{(R-d)^3}{R^3}$$

$$= 1 - \frac{3d}{R} + \dots$$

$$g' = g \left(1 - \frac{3d}{R} \right) \dots\dots\dots(8)$$

Hence, $g' < g$

∴ The acceleration due to gravity decreases with increase in depth.

If $d = R$, then $g' = 0$.

- Weight of a body at the centre of the Earth is zero.

c) Variation of 'g' with latitude

The value of g changes from place to place due to the elliptical shape of the Earth and the rotation of the Earth.

Due to the shape of the Earth,

From equation (4)

$$g = \frac{GM}{R^2}$$

$$g \propto \frac{1}{R^2}$$

Hence, it is inversely proportional to the square of the radius.

∴ It is least at the equator and maximum at the poles, since the equatorial radius is more than the polar radius

UNIFORM CIRCULAR MOTION:-

A body is said to move in circular motion, if it moves in such a way that its distance from a fixed point always remains constant.

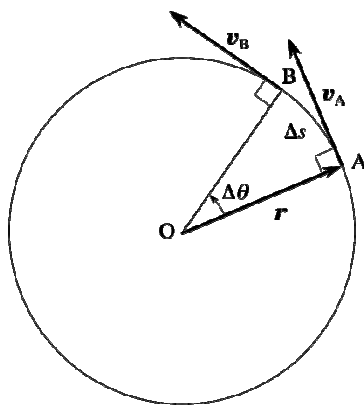

- Uniform circular motion can be described as the motion of an object in a circle at a constant speed.

- As an object moves in a circle, it is constantly changing its direction.
- At all instances, the object is moving tangent to the circle.
- Since the direction of the velocity vector is the same as the direction of the object's motion, the velocity vector is directed tangent to the circle as well.
- An object moving in a circle is accelerating. Accelerating objects are objects which are changing their velocity - either the speed (i.e., magnitude of the velocity vector) or the direction.
- An object undergoing uniform circular motion is moving with a constant speed. It is accelerating due to its change in direction. The direction of the acceleration is inwards.

Angular Displacement (θ) :-

Angular Displacement of a particle in circular motion is defined as the angle turned by its radius vector. It is a vector quantity. It is directed along the axis of rotation.

Angular Velocity (ω) :-

Angular Velocity of a particle in circular motion is defined as the rate of change of angular displacement with time.

Let, the particle moves from A to B in time t.

Then angular velocity = $\frac{\Delta \theta}{\Delta t}$

Angular Acceleration (α) :-

Angular Acceleration of a particle in circular motion is defined as the rate of change of angular velocity with time.

Angular Acceleration = $\frac{\Delta \omega}{\Delta t}$

Relation between Linear displacement (s) and Angular Velocity (ω) :-

From the figure, it is clear that, $\Delta x = r \Delta \theta \Rightarrow \Delta x = r \Delta \theta$

Hence, Linear Displacement = radius \times Angular Displacement

Relation between Linear velocity (v) and Angular Velocity (ω)

$$v = \frac{\Delta x}{\Delta t} = \frac{r \Delta \theta}{\Delta t} = r \omega \Rightarrow v = r \omega$$

Hence, Linear Velocity = radius \times Angular Velocity

Relation between Linear acceleration (a) and Angular acceleration (α)

We have, $a = \frac{\Delta v}{\Delta t} \Rightarrow a = r \alpha$

$$= \frac{\Delta}{r} = \frac{\Delta}{r} = - \Rightarrow = r$$

Hence, Linear acceleration = radius \times Angular acceleration

Simple harmonic motion

Definition:- It is defined as the type of motion in which the restoring force is *proportional* to the displacement from its *mean position of rest* and always *opposes* its increase.

Let , a particle is displaced by a distance y from its mean position and 'F' is the restoring force tends to bring the body to its mean position due to elasticity.

For a small displacement, the force is proportional to the displacement and opposes the increase of displacement.

Hence,

$$F \propto (-) y, \text{ Restoring force } F = \text{mass} \times \text{acceleration}$$

$$\Rightarrow ma = -K y, K = \text{Proportionality constant called force constant}$$

$$\Rightarrow a = - (K/m)y$$

=> $a \propto -y$, the negative sign shows that acceleration is always directed

towards the mean position as it opposes the increase in displacement.

Thus in Simple Harmonic Motion acceleration (a) is directly proportional to the displacement (y) and is always directed towards the mean position.

Examples of SHM :-

1. Vibration of simple pendulum
2. Vibration of a stretched string
3. Vibration of a bell
4. Vibration of a liquid in the two limbs of a U- tube
5. Vertical Vibration of a loaded spring

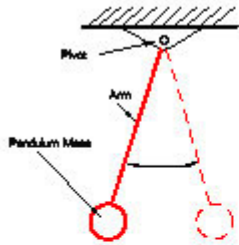

NATURAL VIBRATION

Common Examples of Simple Harmonic Motion at their Natural Frequencies

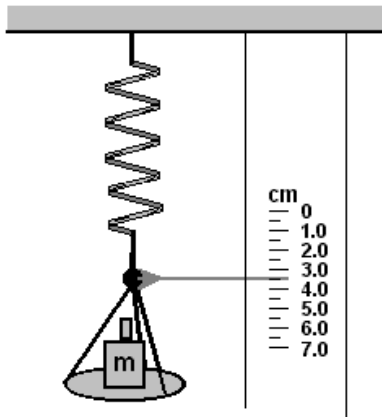
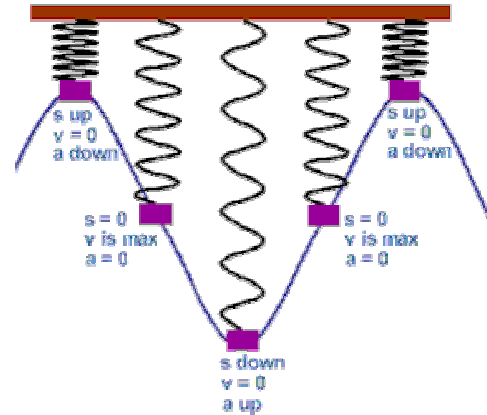
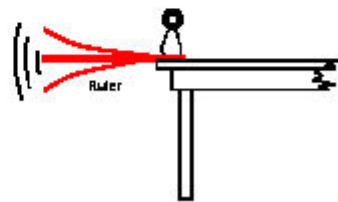

PARAMETERS OF SIMPLE HARMONIC MOTION

Equation of a simple harmonic motion is given by,

$$y = r \sin (\omega t + \phi)$$

r = amplitude of SHM

ω = angular velocity

ϕ = Phase angle

1. **Displacement** : Displacement of a particle vibrating in S.H.M at any instant is defined as its distance from the mean position.
2. **Amplitude** :- Amplitude of a particle vibrating in S.H.M is defined as the maximum displacement on either side of the mean position.
3. **Frequency (n)** :- Frequency of a particle vibrating in S.H.M is defined as the number of vibrations made by the body in one second. $n = 1/T$
4. **Time Period(T)** :- Time period of a particle vibrating in S.H.M is defined as the time required for one complete vibration. $T = \frac{2\pi}{\omega}$
5. **Phase** :- Phase of a particle vibrating in S.H.M is defined as its state as regards its position and direction of motion. It is measured by the fraction of time period that has elapsed since the particle crossed its mean position, last, in the positive direction.

Explanation of SHM as a projection of a uniform circular motion on any diameter

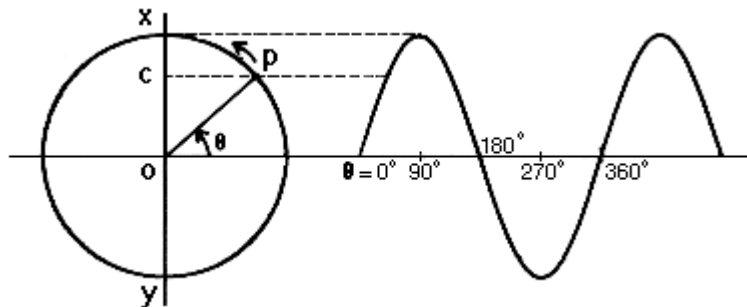

Simple Harmonic Motion can be explained as a projection of a uniform circular motion on the diameter XY given in the figure above.

Let, C be the position of projection at P at any instant of time t.

Time t is measured from the instant when the particle C was at O.

OC = Displacement of the particle at time t = y

OP = Radius of the reference circle = r

θ = Angular Displacement
 ω = angular velocity

Derivation of velocity and acceleration of a particle executing SHM

i. Displacement :-

In the triangle OPC, $\sin \theta = \frac{OC}{OP}$

$$\Rightarrow OC = OP \sin \theta$$

$$\Rightarrow y = r \sin \theta$$

Amplitude = Maximum Displacement = $y = \pm r$

(As maximum values of $\sin \theta$ is ± 1)

ii. Velocity :-

Velocity = $v = \frac{dy}{dt} = \frac{d}{dt}(r \sin \theta) = r \cos \theta \frac{d\theta}{dt} = v \cos \theta$, (as $v = r \omega$)

We know that, $\sin \theta = \frac{y}{r} \Rightarrow \cos \theta = \sqrt{1 - y^2/r^2} = \frac{\sqrt{r^2 - y^2}}{r}$

$$V = r \cos \theta \frac{d\theta}{dt} = r \times \frac{\sqrt{r^2 - y^2}}{r} \times \frac{d\theta}{dt} = \sqrt{r^2 - y^2} \frac{d\theta}{dt}$$

Hence, $V = \sqrt{r^2 - y^2} \frac{d\theta}{dt}$, gives the expression for velocity at any instant of time for a particle executing SHM.

a) At the mean position O, displacement ,
 $y = 0$

Hence, $V = \omega \times \sqrt{r^2 - 0} = r\omega = v = \text{linear velocity i.e. maximum velocity}$

b) At the extreme position, $y = r$

Hence, $V = \omega \times \sqrt{r^2 - r^2} = 0$

Thus , a particle vibrating in SHM has maximum velocity at the mean position and zero at the extreme position.

iii. Acceleration :-

$$\begin{aligned} \text{Acceleration} = a &= \frac{d^2y}{dt^2} = \frac{d}{dt} \left(\frac{dy}{dt} \right) = \frac{d}{dt} (r\omega \cos \omega t) = r\omega \frac{d}{dt} (\cos \omega t) \\ &= r\omega \times -\sin \omega t = -r\omega^2 \sin \omega t = -\omega^2 (r \sin \omega t) = -\omega^2 y \end{aligned}$$

Hence, $a = -\omega^2 y$, gives the expression for acceleration at any instant of time for a particle executing SHM.

Thus it is proved that the acceleration of a particle executing SHM is proportional to the displacement and is in the opposite direction towards mean position.

a) At the mean position O,
displacement , $y = 0$

Hence, $a = -\omega^2 y = 0$

b) At the extreme position, $y = r$

Hence, $a = -\omega^2 r = -a_{\text{max}}$

Thus , a particle vibrating in SHM has zero acceleration at the mean position and maximum acceleration at the extreme position.

Hence it can be concluded that the motion of a body is said to Simple Harmonic Motion, if it moves in such a way that the the acceleration is directly proportional to the displacement and is always directed towards the mean position.

UNIT-4

SOUND &

ACCOUSTICS

SOUND & ACOUSTICS

Basic Concepts :-

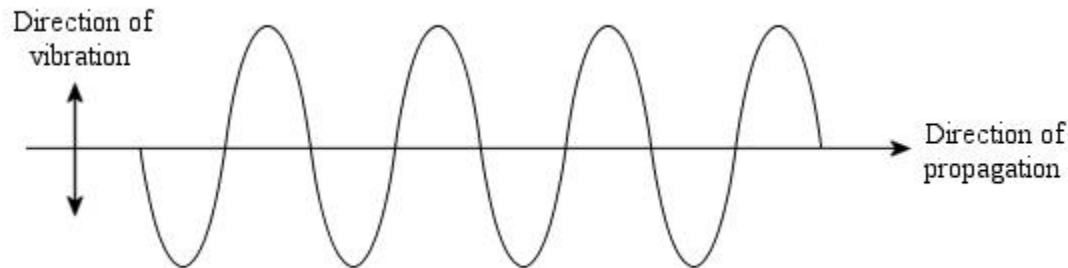

- **Wave Motion** - It is a form of disturbance that travels through the medium due to repeated periodic motion of particles about their mean positions: the motion being transferred from particle to particle without transfer of matter.
- Wave is a disturbance which propagates energy and momentum from one part to another in a medium without transport of matter.
- **Types of Waves :-**
 1. **Mechanical or Elastic waves :-**

Material medium Essential for propagation.
Ex- Sound waves
 2. **Non- mechanical waves or Non- Elastic waves**

Material medium not Essential for propagation.
Ex- Light waves, Electromagnetic waves
 3. **Matter waves:-**

Associated with electrons, protons and other fundamental particles.
Ex - De-broglie waves,
- Velocity of sound waves in AIR (at 0° c) is 332m/sec
- Sound waves need a medium for propagation.

LONGITUDINAL WAVES

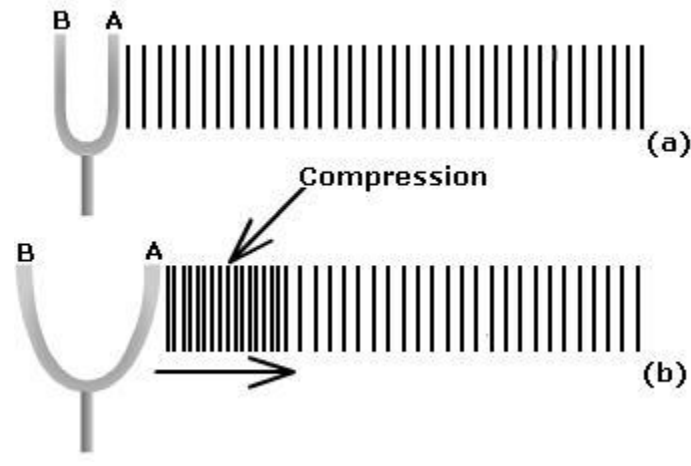

- Longitudinal waves are waves in which the displacement of the particles of the medium is parallel to the direction of the propagation of the wave.
- When a longitudinal wave passes through a medium, some layers come close together creating a compression. At other places, particles move further apart forming rarefaction.
- Material medium essential for propagation of Longitudinal waves.
- Pressure and density are maximum at compressions and minimum at rarefactions.

Example: - i) Waves produced in a string suspended in a vertical position when pulled along its length.

ii) Sound waves

iii) Waves along a cord (String) fixed at one end, the other end made to vibrate to and fro.

TRANSVERSE WAVES

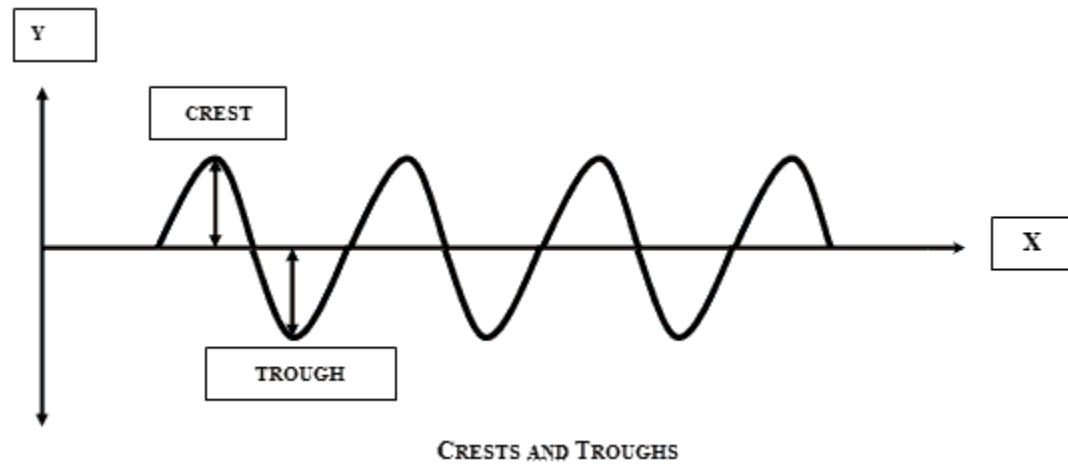

- Transverse waves are waves in which the displacement of the particles of the medium is perpendicular to the direction of the wave motion.
- Transverse wave is propagated in the form of crests and troughs.
- Material medium not essential for propagation. Can travel with or without material medium.
- There is no pressure variation throughout the medium.

Examples: - 1. Light waves

2. electromagnetic waves

3. water waves in a shallow pond.

4. waves along a string fixed at both ends, but plucked at a point.

COMPARISON BETWEEN "LONGITUDINAL AND TRANSVERSE WAVES"

P waves are longitudinal waves

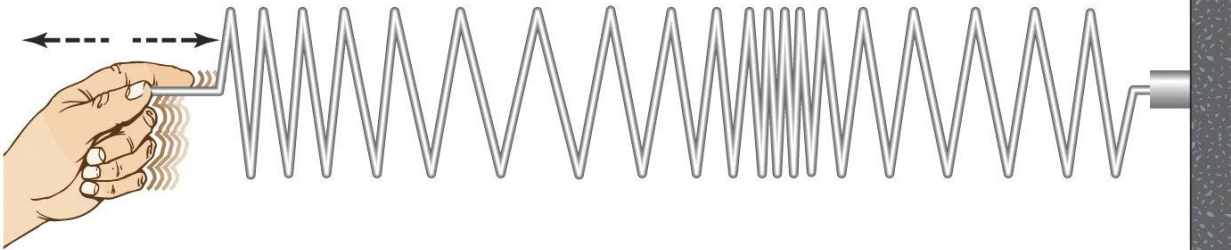

S waves are transverse waves

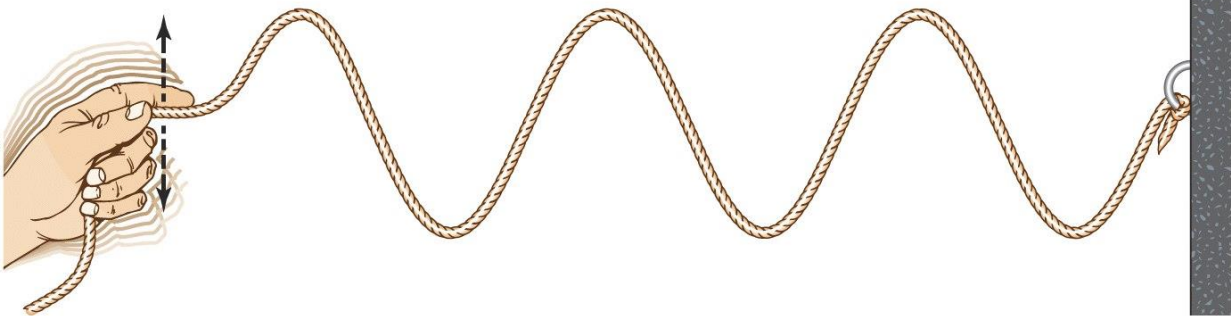

Transverse Waves and Longitudinal Waves

Transverse waves	Longitudinal waves
In Transverse waves the displacement of the particles of the medium is perpendicular to the direction of the wave motion.	In Longitudinal waves the displacement of the particles of the medium is parallel to the direction of the propagation of the wave.
Transverse wave is propagated in the form of crests and troughs.	Longitudinal wave is propagated in the form of compressions and rarefactions.
Material medium not essential for propagation	Material medium essential for propagation
There is no pressure variation throughout the medium.	Pressure varies and is maximum at compressions and minimum at rarefactions.
Example: - Light Waves	Example: - Sound waves

PROGRESSIVE WAVES

- A progressive wave is one which travels onward (forward) in a particular direction with a definite velocity and constant amplitude.
- Such waves (progressive waves) are produced by the periodic vibration of particles in a medium about their mean positions and move forward with specific velocity and fixed amplitude without attenuation.

Example: - I) Longitudinal waves

II) Transverse waves

- Also called a travelling wave are running wave or displacement wave.
- A progressive wave travels from one place to another resulting in a transfer of energy.

STATIONARY WAVES :-

- **Standing waves** (also known as **stationary waves**) are set up as a result of the superposition of two waves with the same amplitude and frequency, travelling at the same speed, but in opposite directions.
- The waves are moving, but the same places have a very large amplitude oscillation while others have zero amplitude and continuous destructive interference.
- Stationary waves may be set up when a wave reflects back from a surface and the reflected wave interferes with the wave still travelling in the original direction.
- The reflected wave and the incoming wave interfere. For example, at the reflecting surface the two waves are always exactly equal and opposite - so they always cancel out. Such a place is called a **NODE**.

At other points along the waves, the two ways always are the same - so they add together or interfere constructively and make a double size wave. Such points are called **ANTINODES**.

- Examples :-

In strings (under tension) Transverse stationary waves are formed

In organ pipes Longitudinal Stationary Waves are produced.

Amplitude is minimum --- at nodes and Maximum ---- at anti-nodes.

- From the diagram it can be seen that when a wave reflects, it comes back inverted (for example a crest becomes a trough).

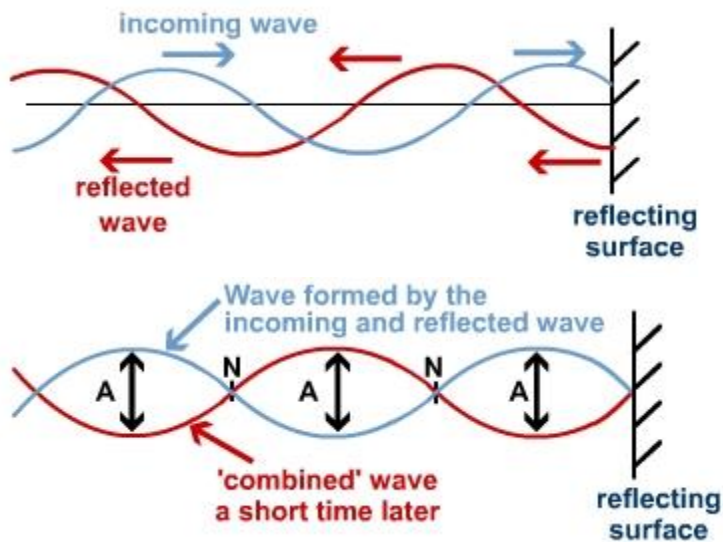

- A - places where the waves interfere constructively and make double height wave - **ANTINODE**.
- N - places where the two waves always 'cancel' out so there is no movement.
- The distance between two **NODES** or between two **ANTINODES** is **half a wavelength**.
- The distance between a **NODE** and the next **ANTINODES** is **one quarter of a wavelength**.

Progressive Waves and Stationary Waves

Progressive waves	Stationary waves
The disturbance produced in the medium travels onward, it being handed over from one particle to the next. Each particle executes the same type of vibration as the preceding one, though not at the same time.	There is no onward motion of the disturbance as no particle transfers its motion to the next. Each particle has its own characteristic vibration.
The amplitude of each particle is the same but the phase changes continuously,	The amplitudes of the different particles are different, ranging from zero at the nodes to maximum at the antinodes. All the particles in a given segment vibrate in phase but in opposite phase relative to the particles in the adjacent segment.
No particle is permanently at rest. Different particles attain the state of momentary rest at different instants,	The particles at the nodes are permanently at rest but other particles attain their position of momentary rest simultaneously.
All the particles attain the same maximum velocity when they pass through their mean positions.	All the particles attain their own maximum velocity at the same time when they pass through their mean positions.
In the case of a longitudinal progressive wave all the parts of the medium undergo similar variation of density one after the other. At every point there will be a density variation.	In the case of a longitudinal stationary wave the variation of density is different at different points being maximum at the nodes and zero at the antinodes.
There is a flow of energy across every plane in the direction of propagation.	Energy is not transported across any plane.

Different wave parameters

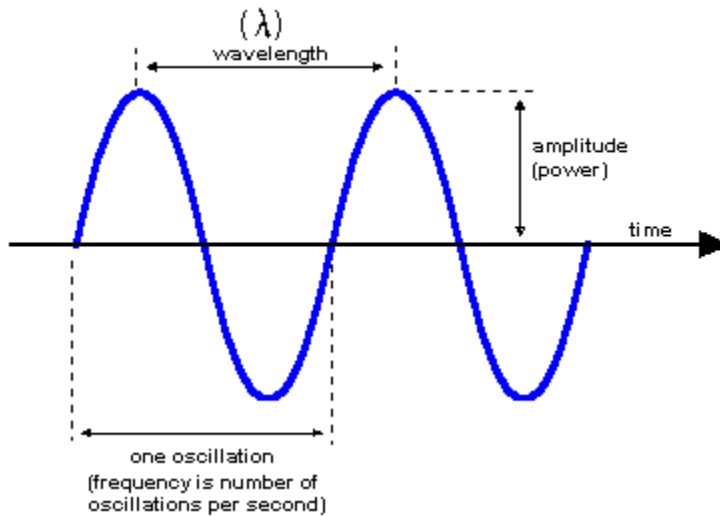

- **Amplitude (a)** :- Maximum displacement of the particle (in the medium) on either side of mean or equilibrium position is called amplitude.

SI Unit----- Metre

Dimension ----- (L)

- **Time-period- (T)** :- Time taken by a particle of the medium to describe or complete one full wave is called Time- period.

SI Unit----- Second

Dimension ----- (T)

- **Frequency (f or n)** :- It is the number of complete waves/full cycles described by the particle in 1 second.

SI Unit----- Cycles/Second = HERTZ (Hz)

Dimension ----- (T^{-1})

- Wave length (λ) ---- It is the linear distance covered during one full wave or one full cycle.

SI Unit---- Metre

Dimension ----- (L)

- Wave Velocity (v) ---- The linear distance covered or travelled by a wave per unit time (in 1 sec)

SI Unit----- Metre /second

Dimension ----- (L/T) or (LT⁻¹)

- Relation between frequency (f) and Time- period (T) : -

Let **f** – frequency of wave i.e. ‘f’ number of waves are described in 1 sec.

T – Time period of a wave i.e. time taken to describe/complete 1 wave.

f number of waves are described in 1 sec.

⇒ 1 wave is described in 1/f second

We know that time taken to describe 1 wave is called time-period (T).

So, **T = 1/f**

And **f = 1/T**

Thus, Frequency and time-period of a wave are reciprocal of each other.

Relation between frequency wave length & velocity of wave: -

Let V = Velocity of the wave

F = Frequency of the wave

λ = wave length of the wave

T = Time period of the wave

We know that , speed = distance/time.

If the time for one complete wave is the **time period, T** and the distance is the **wavelength, λ** , then:

$$\text{Speed, } v = \frac{\text{distance}}{\text{time}} = \frac{\lambda}{T}$$

$$\text{But, as frequency} = \frac{1}{\text{Time period}}$$

$$v = \frac{\lambda}{T} \text{ becomes } v = \lambda f$$

ULTRASONICS

- The branch of Physics which deals with study of ultrasonic waves is called Ultrasonic.
- Ultrasound is acoustic (sound) energy in the form of waves having a frequency above the human hearing range. The highest frequency that the human ear can detect is approximately 20 thousand cycles per second (20,000 [Hz](#)). Ultrasound devices operate with frequencies from 20 kHz up to several gigahertz.

Properties of Ultrasonic waves :

- The ultrasonic waves are high frequency sound waves.
- They are having smaller wavelength.
- They produce heating effect when passes through the medium.
- They get reflected, refracted and absorbed by the medium similar to the ordinary sound waves.
- They act as catalytic agents to accelerate chemical reactions.
- They produce stationary wave pattern in the liquid while passing through it.

APPLICATIONS OF ULTRASONIC WAVES: -

- Ultrasound can be used in [sonar](#) systems to determine the depth of the water in a location, to find schools of fish, to locate submarines, and to detect the presence of SCUBA divers.
- **Echo Sounding** : -High powered ultrasonic pulses are emitted and received back after reflection from the obstacle. Depth of Sea is calculated by this method. Moreover, detection of sunk ships and submarines is also done.
- **Diagnostic use**: - Such waves are used to detect tumourous, soft tissue structures, lesions, and abnormal growth in the body.
- **Sterilisation purposes**: - Ultrasonic waves destroy living organism like bacteria or even small insects.
- **Drilling Holes**: - Ultrasonic drills are used for machining (making holes/attening shapes etc) aluminium, titanium, tungsten, molybdenum, mica, granite etc.
- **Ultrasonic cleaning** : - Components to be cleaned are immersed in a washing solution of trichloroethylene and ultrasonic oscillations are excited in it. Boiler scums are removed. Walls of petroleum wells are de-paraffined. Remotest pores are cleaned.
- **Coagulation** : - Fine particles of dust, smoke, ash, fog etc collide against each other and bind forming bigger particles when subjected to Ultrasonic waves. This method is employed by industries to remove smoke from industrial stack, acid fumes etc.

DOPPLER'S EFFECT

DEFINITION: -

The apparent change ((increase / decrease) in the frequency (pitch) of sound (wave) due to relative motion between SOURCE and LISTENER along with the line of sight is called Doppler's Effect.

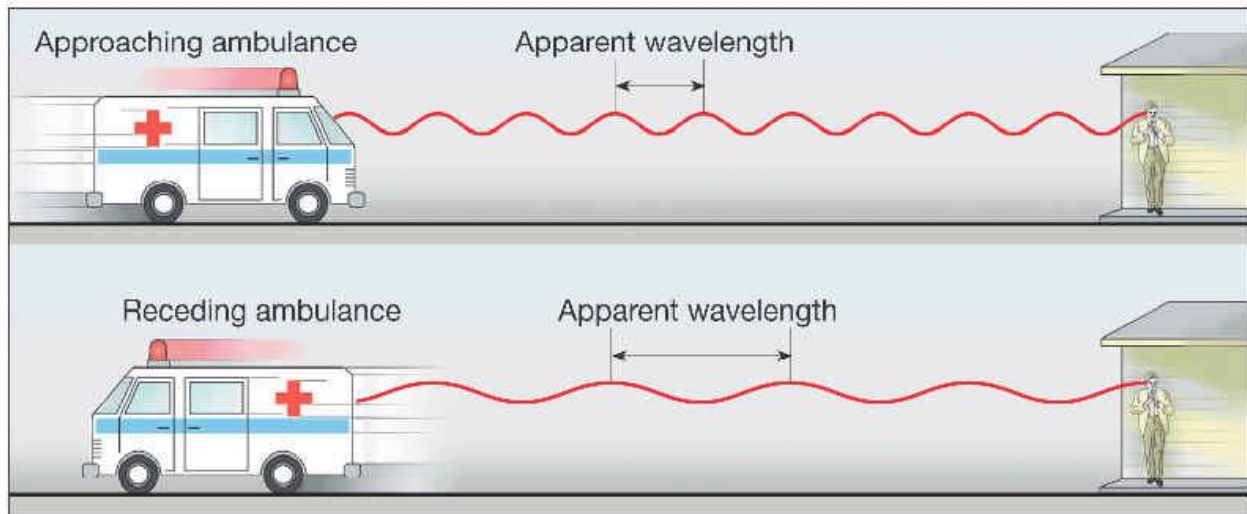

- Pitch is that characteristics of sound that depends on frequency. It determines the shrillness or graveness of sound.

Frequency of ladies voice is higher than gents . hence, ladies voice has higher pitch.

Example": -

A man is standing on a Railway Platform. When an engine sounding horn approaches him, frequency (pitch) appears to increase and in maximum when it just crosses. Subsequently, the frequency appears to decrease.

CONCEPTUAL EXPLANATION OF DIFFERENT CASES :-

Let : - n = Actual frequency of sound (form source)

n' = apparent (observed) frequency of sound (as heard by listener)

Source in motion , Listener at Rest	Remark/outcome/result
i. Source in motion towards listener	i. Apparent frequency INCREASES ($n' > n$)
ii. Source in motion away from listener	ii. Apparent frequency DECREASES ($n' < n$)
Source at rest , Listener in motion	
i. Listener in motion towards Source	i. Apparent frequency INCREASES ($n' > n$)
ii. Listener in motion away from Source	ii. Apparent frequency DECREASES ($n' < n$)
Source and Listener in both in motion	
i. Source and listener moving towards each other	i. Apparent frequency INCREASES ($n' > n$)
ii. Source and listener moving away from each other	ii. Apparent frequency DECREASES ($n' < n$)
iii. Source & listener moving in the same direction	a) if they moves with equal velocities, the apparent frequency does not change (remains same). b) if they move with un equal velocities, the apparent frequency of sound changes (increase or decreaes) depending on the velocities of both

APPLICATIONS OF DOPPLER'S EFFECT :-

- Principle of Doppler's effect is used in **RADAR** to determine the position, distance and velocity of fast moving objects in SKY relative to the ground. Electromagnetic waves used in RADAR do not require a medium for propagation.
- Also used in **SONAR** to determine the position, distance and velocity of submarines relative to the Ocean.
- Used in **ASTROPHYSICS** to locate position, distance and velocity of Stars. The light received from the stars are found to have Doppler's shift to frequency towards red end of the spectrum. This indicates stars are moving away from us.
- **Check speed of Automobiles:** - A traffic officer can calculate the speed of an approaching or receding automobile by noting a change in the pitch of its horn. If the speed crosses safe limit, the driver can be booked for rash driving.

UNIT – 5
HEAT AND
THERMODYNAMICS

HEAT AND THERMODYNAMICS :-

- Heat is a form of Energy.
- Heat means Heat Energy.
- Temperature measures the degree of hotness or coldness of a body.
- When a body or object gains heat its temperature increases.
- When a body or object loses heat its temperature decreases.

UNITS FOR MEASURING HEAT :-

	<u>System</u>	<u>Unit</u>	
		HEAT	Temperature
i)	FPS	British Thermal Unit (B.T.U)	$^{\circ}\text{F}$ (Degree Farenhite)
ii)	CGS	Calorie (Cal)	$^{\circ}\text{C}$ (Degree Centigrade)
iii)	MKS	Kilo- Calorie (K Cal)	$^{\circ}\text{C}$ (Degree Centigrade)
iv)	SI	Joule	$^{\circ}$ (Degree Kelvin)

- **1 Kilo- Calorie (K Cal) = 1000 Calorie**
- **1 B.T.U = 252 Calorie**

Expansion of Solids

Conceptual Points

- ☐ Solids on *heating* (generally).
- ☐ Expansion means increase in dimensions (size) of the solid.
- ☐ Solids are of three types
 - A) One Dimensional (1-D)
 - B) Two Dimensional (2-D)
 - C) Three Dimensional (3-d)

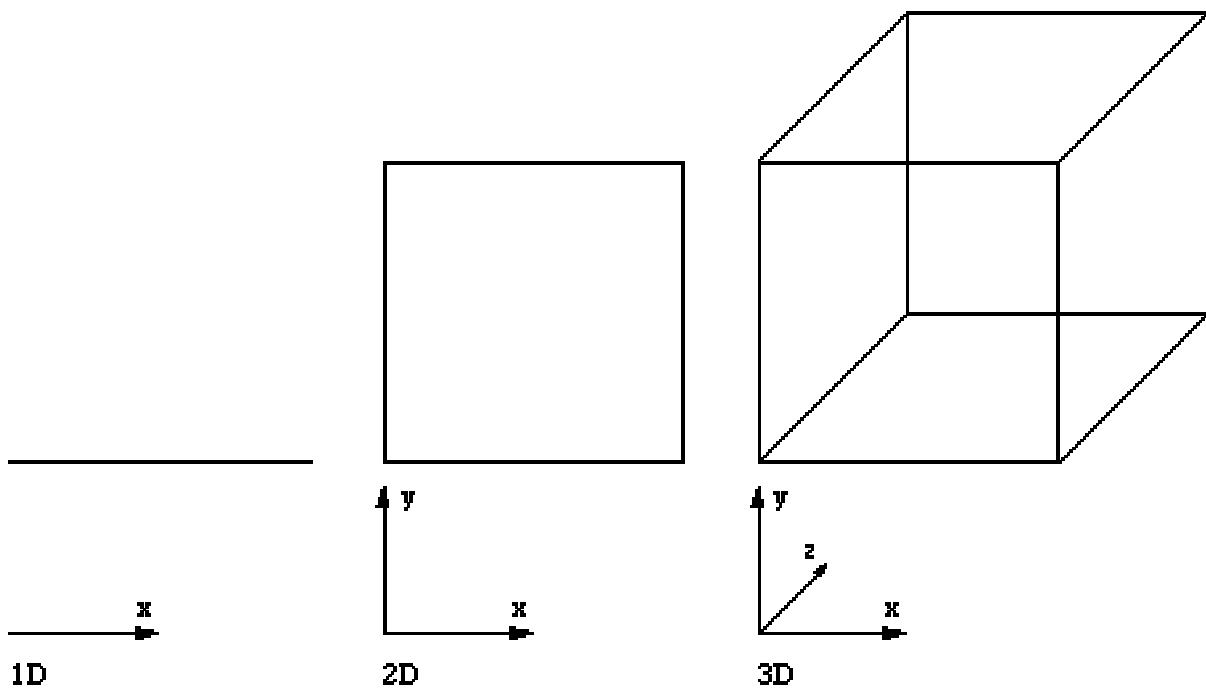

- ☐ A 1-D solid has only one prominent or significant dimension i.e. *length*
- ☐ A two dimensional solid has only two prominent or significant dimensions i.e. *length* and *breadth*
- ☐ A three dimensional solid has three prominent or significant dimensions i.e. length, breadth and height
- ☐ **Linear Expansion** is only possible in case of *one dimensional* solids on heating.
- ☐ **Areal Expansion or Superficial Expansion** occurs in case of two dimensional solids on heating.
- ☐ **Volume Expansion or Cubical Expansion** occurs in case of three dimensional solids on heating.
- ☐ One dimensional solid \longrightarrow size means length.
- ☐ Two dimensional solid \longrightarrow size means area.
- ☐ Three dimensional solid \longrightarrow size means volume.

Types of Expansion in solids

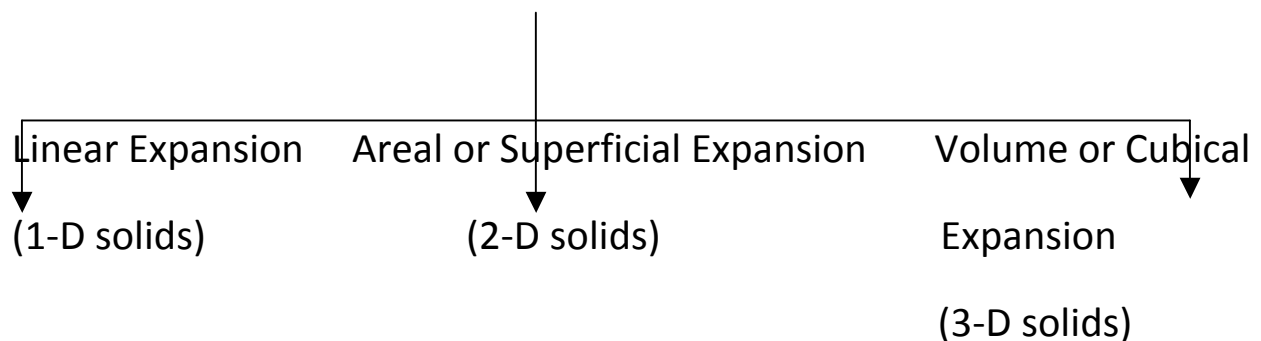

Linear Expansions-Increase in length of solid on heating is called linear expansion.

Areal Expansion-Increase in area of a solid on heating is called areal expansion or superficial expansion.

Volume Expansion-Increase in volume of a solid on heating is called volume expansion or cubical expansion.

Co-efficient of Expansion

The expanding abilities of different solid materials are different. The *co-efficient of expansion* of a solid refers to its expanding abilities.

Types of co-efficient of expansion

- Co-efficient of linear expansion(α) or linear expansivity
- Co-efficient of Areal expansion(β) or areal expansivity
- Co-efficient of volume expansion(γ) or volume expansivity
- Co-efficient of expansion refers to the *material* of solid, not the object.

For example,

Steel Rod Material-Steel

Object-Rod

α belongs to steel not rod.

Formula for Co-efficient of Linear Expansion(α)

Let,

L_0 = The length of solid rod at 0°C

L_t = The length of solid rod (after heating) at $t^\circ\text{C}$

Increase in length of rod = $L_t - L_0$

Increase in temperature of rod = $t - 0 = t^\circ\text{C}$

$$L_t - L_0 \propto \text{Original length } (L_0)$$

$$L_t - L_0 \propto \text{Rise in temperature}(t)$$

Therefore,

$$L_t - L_0 \propto L_0 t$$

$$L_t - L_0 = \alpha L_0 t$$

' α ' is the proportionality constant known as Co-efficient of Linear Expansion or Linear Expansivity of Solid(Material)

$$= \frac{\quad}{\quad}$$

Relation between L_t and L_0

$$L_t - L_0 = \alpha L_0 t$$

Or $L_t = L_0 + \alpha L_0 t$

$L_t = L_0(1 + \alpha t)$

Unit of α

$$= \frac{\text{m}}{\text{m} \cdot \text{K}} \rightarrow \frac{\text{m}}{\text{m} \cdot \text{K}} \rightarrow \frac{1}{\text{K}} = \text{K}^{-1}$$

Another formula for —

Let, L_1 = The length of solid rod at t_1 °C

L_2 = The length of solid rod (after heating) at t_2 °C

Increase in length of rod = $L_2 - L_1$

Increase in temperature of rod = $t_2 - t_1$

$L_2 - L_1 \propto L_1$ (Original length at t_1 °C)

$L_2 - L_1 \propto (t_2 - t_1)$ Rise in temperature

Therefore,

$L_2 - L_1 \propto L_1(t_2 - t_1)$

$$L_2 - L_1 = \alpha L_1(t_2 - t_1)$$

α = Proportionality constant known as Co-efficient of Linear Expansion of the solid

$$\alpha = \frac{\Delta L}{L_1 \Delta T}$$

Relation between L_2 and L_1

$$L_2 - L_1 = \alpha L_1(t_2 - t_1)$$

Or $L_2 = L_1 [1 + \alpha(t_2 - t_1)]$

Definition of α

α of a solid is defined as the increase in length per unit original length per unit degree rise in temperature.

$$= \frac{\Delta L}{L_1 \Delta T}$$

OR

$$\alpha = \frac{\Delta L}{L_1 \Delta T}$$

Unit of $\alpha \rightarrow$ CGS Unit = $^{\circ}\text{C}^{-1}$

MKS Unit = $^{\circ}\text{K}^{-1}$

Dimension of $\alpha \rightarrow [M^0 L^0 T^0 K^{-1}]$

Formula for Co-efficient of Areal or Superficial Expansion(β)

Let,

A_0 =The Area of solid Plate at 0°C

A_t =The Area of solid Plate (after heating) at $t^\circ\text{C}$

Increase in Area of Plate = $A_t - A_0$

Increase in temperature of Plate= $t - 0 = t^\circ\text{C}$

$A_t - A_0 \propto$ Original Area (A_0)

$A_t - A_0 \propto$ Rise in temperature(t)

Therefore,

$$A_t - A_0 \propto A_0 t$$

$$A_t - A_0 = \beta A_0 t$$

' β ' is the proportionality constant known as Co-efficient of Superficial Expansion

$$= \frac{\Delta A}{A_0 \Delta t}$$

Relation between A_t and A_0

$$A_t - A_0 = \beta A_0 t$$

$$\text{Or, } A_t = A_0 + \beta A_0 t$$

$$A_t = A_0(1 + \beta t)$$

Unit of β

$$= \frac{\Delta A}{A_0 \Delta t} \rightarrow \frac{m^2}{m^2 \times ^\circ C} \rightarrow ^\circ C^{-1}$$

Another formula for β

Let,

A_1 = The Area of solid Plate at t_1 °C

A_2 = The Area of solid Plate (after heating) at t_2 °C

Increase in Area of rod = $A_2 - A_1$

Increase in temperature of rod = $t_2 - t_1$

$A_2 - A_1 \propto A_1$ (Original length at t_1 °C)

$A_2 - A_1 \propto (t_2 - t_1)$ Rise in temperature

Therefore,

$$A_2 - A_1 \propto A_1(t_2 - t_1)$$

$$A_2 - A_1 = \beta A_1(t_2 - t_1)$$

β = Proportionality constant known as Co-efficient of Superficial Expansion of the solid

$$\beta =$$

Relation between A_2 and A_1

$$A_2 - A_1 = \beta A_1(t_2 - t_1)$$

Or $A_2 = A_1 [1 + (\quad - \quad)]$

Definition of β

β of a solid is defined as the increase in Area per unit original Area per unit degree rise in temperature.

$$= \frac{\Delta A}{A \Delta T}$$

OR

$$\beta = \frac{\Delta A}{A \Delta T}$$

Unit of $\beta \rightarrow$ CGS Unit = $^{\circ}\text{C}^{-1}$, MKS Unit = $^{\circ}\text{C}^{-1}$

Dimension of $\beta \rightarrow [M^0 L^0 T^0 K^{-1}]$

Formula for Co-efficient of Volume or Cubical Expansion (γ)

Let, V_0 = The Volume of solid cube at 0°C

V_t = The Volume of solid cube (after heating) at $t^{\circ}\text{C}$

Increase in Volume of cube = $V_t - V_0$

Increase in temperature of Plate = $t - 0 = t^{\circ}\text{C}$

$V_t - V_0 \propto$ Original Volume (V_0)

$V_t - V_0 \propto$ Rise in temperature (t)

Therefore,

$$V_t - V_0 \propto V_0 t$$

$$V_t - V_0 = \gamma V_0 t$$

' γ ' is the proportionality constant known as Co-efficient of Superficial Expansion

$$= \frac{\Delta V}{V_0 \Delta t}$$

Relation between V_t and V_0

$$V_t - V_0 = \gamma V_0 t$$

Or, $V_t = V_0 + \gamma V_0 t$

$$V_t = V_0(1 + \gamma t)$$

Unit of γ

$$= \frac{\Delta V}{V_0 \Delta t} \rightarrow \frac{m^3}{m^3 \times s} \rightarrow s^{-1} = \text{per } ^\circ C$$

Another formula for γ

Let, V_1 = The Volume of solid Cube at $t_1^\circ\text{C}$

V_2 = The Volume of solid Cube (after heating) at $t_2^\circ\text{C}$

Increase in Volume of rod = $V_2 - V_1$

Increase in temperature of rod = $t_2 - t_1$

$V_2 - V_1 \propto V_1$ (Original Volume at $t_1^\circ\text{C}$)

$V_2 - V_1 \propto (t_2 - t_1)$ Rise in temperature

Therefore, $V_2 - V_1 \propto V_1(t_2 - t_1)$ Type equation here.

$$V_2 - V_1 = \gamma V_1(t_2 - t_1)$$

γ = Proportionality constant known as Co-efficient of Cubical Expansion of the solid

$$\gamma = \frac{\Delta V}{V_1 \Delta t}$$

Relation between V_2 and V_1

$$V_2 - V_1 = \gamma V_1 (t_2 - t_1)$$

Or $V_2 = V_1 [1 + \gamma (t_2 - t_1)]$

Definition of γ

γ of a solid is defined as the increase in Volume per unit original Volume per unit degree rise in temperature.

$$\gamma = \frac{\Delta V}{V_1 \Delta t}$$

OR
$$\gamma = \frac{\Delta V}{V_1 \Delta t}$$

Unit of $\gamma \rightarrow$ CGS Unit = $^{\circ}\text{C}^{-1}$, MKS Unit = $^{\circ}\text{C}^{-1}$

Dimension of $\gamma \rightarrow [M^0 L^0 T^0 K^{-1}]$

RELATION BETWEEN α and β :-

Let us consider a solid plate with the following parameters.

L_0 = Length of Plate at 0°C , B_0 = Breadth of Plate at 0°C

L_t = Length of Plate at $t^{\circ}\text{C}$, B_t = Breadth of Plate at $t^{\circ}\text{C}$

A_0 = Area of Plate at 0°C

A_t = Area of Plate at $t^{\circ}\text{C}$

α → Co-efficient of Linear Expansion of the material

β → Co-efficient of Superficial Expansion of the material

We know that,

$$A_t = A_0(1+\beta t)$$

$$\text{Or } L_t B_t = L_0 B_0(1+\beta t)$$

$L_t = L_0(1+\alpha t)$ $B_t = B_0(1+\alpha t)$

Areal or superficial expansion is the result of two simultaneous linear expansion along length and breadth, therefore,

$$L_0 (1+\alpha t) B_0(1+\alpha t) = L_0 B_0(1+\beta t)$$

$$\text{Or } (1+\alpha t)^2 = 1+\beta t$$

$$\text{Or } 1+\beta t = (1+\alpha t)^2$$

$$\text{Or } 1+\beta t = 1+2\alpha t + \alpha^2 t^2$$

As α is very small, the higher powers of α i.e. α^2 is further small so $\alpha^2 t^2$

can be neglected from the expression

Which reduces the expression to,

$$1+\beta t = 1+2\alpha t$$

So, $\beta = 2\alpha$

Relation between α and γ

Let us consider a solid with the following parameters.

L_0 = Length of solid at 0°C , B_0 = Breadth of solid at 0°C , H_0 = Height of solid at 0°C

L_t = Length of solid at $t^\circ\text{C}$, B_t = Breadth of solid at $t^\circ\text{C}$, H_t = Height of solid at $t^\circ\text{C}$

V_0 = Area of Plate at 0°C

V_t = Area of Plate at $t^\circ\text{C}$

α → Co-efficient of Linear Expansion of the material

γ → Co-efficient of Cubical Expansion of the material

We know that,

$$V_t = V_0(1+\gamma t)$$

$$\text{Or } L_t B_t H_t = L_0 B_0 H_0 (1+\gamma t)$$

$\begin{aligned} L_t &= L_0(1+\alpha t) \\ B_t &= B_0(1+\alpha t) \\ H_t &= H_0(1+\alpha t) \end{aligned}$
--

Areal or superficial expansion is the result of three simultaneous linear expansion along length, breadth and height, therefore,

$$L_0 (1+\alpha t) B_0(1+\alpha t) H_0(1+\alpha t) = L_0 B_0 H_0 (1+\gamma t)$$

$$\text{Or } (1+\alpha t)^3 = 1+\gamma t$$

$$\text{Or } 1+\gamma t = (1+\alpha t)^3$$

$$\text{Or } 1+\gamma t = 1+3\alpha t+3\alpha^2 t^2+\alpha^3 t^3$$

As α is very small, the higher powers of α i.e α^2 and α^3 are further small so $\alpha^2 t^2$ and $\alpha^3 t^3$ can be neglected from the expression

Which reduces the expression to,

$$1+\gamma t = 1+3\alpha t$$

Or

$$\gamma = 3 \alpha$$

Relation between α , β and γ

We have already derived,

$$\beta = 2 \alpha$$

$$\gamma = 3 \alpha$$

Hence, we have,

$$\alpha = \beta / 2 = \gamma / 3$$

$$\text{Or } \alpha : \beta : \gamma = 1:2:3$$

Thermodynamics

1st Law of Thermodynamics

The branch of Science(physics) which deals with the transformation of heat energy into other forms of energy and vice-versa is called *thermodynamics*.

OR

The study of heat and its transformation to mechanical energy is called *thermodynamics*.

OR

Thermodynamics is the study of interactions between heat and other forms of energy.

Thermodynamics is derived from Greek words *thermos* which means 'heat' and *dynamics* which means 'power'.

Thermodynamic System:-

A definite amount of matter bounded by some closed surface.

Ex:- Container with gas having Pressure (P), Volume (V) and temperature (T).

Statement of 1st Law of Thermodynamics :-

Heat given to a system (ΔQ) is equal to the sum of increase in its internal energy (ΔU) and the work done (ΔW) by the system against the surroundings.

$$\Delta Q = \Delta U + \Delta W$$

Explanation:- i) Based on the idea that energy is neither created nor destroyed i.e the law obeys the Law of Conservation of Energy.

ii) Internal Energy of a System= Kinetic Energy+ Potential Energy

iii) Internal Energy of a System increases when heat flows into it and decreases when heat flows out of it.

iv) Internal Energy changes when work is done.

a) Compressing a gas increases internal energy.

b) Expansion of a gas results in decrease of its internal energy.

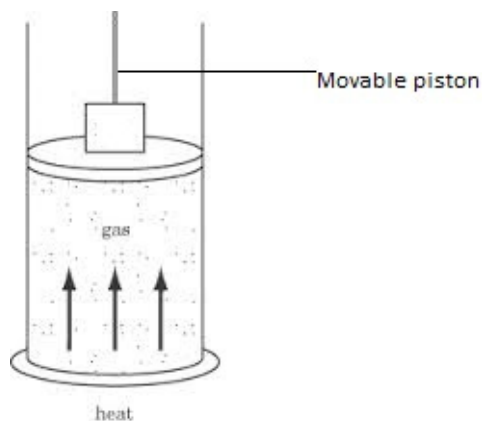

Internal energy of an ideal gas (molecules with no or negligible intermolecular force) depends only on temperature.

Internal energy=Kinetic energy +potential energy

As it is an ideal gas,there is no intermolecular force between the molecules,so the potential energy is zero.

Hence,

Internal energy=Kinetic energy

In practice or reality no gas is ideal. There is always some deviation from ideal behavior.

MECHANICAL EQUIVALENT OF HEAT

Introduction:-

- i) Whenever Mechanical work is done on a system, Heat is produced.
- ii) Work and Heat are interconvertible i.e Heat can be expressed in terms of Work and Work can also be expressed in terms of Heat.

Work ↔ Heat

JOULE'S LAW

Statement :- Whenever Work is converted into Heat or Heat is converted into Work, the quantity of Heat disappearing in one form is equivalent to the quantity of energy appearing in the other form.

Thus work and heat are directly proportional to each other.

If, W = work done

H = Heat produced

Then, $W \propto H$

Or, $W = JH$

Here 'J' is the proportionality constant known as Mechanical Equivalent of Heat.

Mechanical Equivalent of Heat is defined as the amount of work done to produce unit quantity of heat.

$H(\text{heat}) \longrightarrow W(\text{work done})$

$1(\text{unit quantity}) \longrightarrow \bar{\quad}(\text{work done}) = J$

Value of 'J', $J = 4.2 \text{ joule/calorie (S.I. Unit)}$

Which means 1 calorie of heat is produced when 4.2 joule of work is done.

Specific Heat of Gases [C_p , C_v]

Introduction

When the temperature of a solid or liquid changes, variation in pressure and volume are small and normally neglected. Hence, solids have been assigned a specific heat of one.

However, when a gas is heated, there is large (significant) change in pressure and volume which cannot be neglected. Hence, each gas has two values of specific heat, one at constant volume (C_v) and another at constant pressure (C_p).

Specific Heat at Constant Pressure (C_p)

It is the amount of heat required to raise (increase) the temperature of unit mass of a gas by unit degree (1°C or 1 K or 1°F) at constant pressure.

Specific Heat at Constant Volume (C_v)

It is the amount of heat required to raise (increase) the temperature of unit mass of a gas by unit degree (1°C or 1 K or 1°F) at volume.

Relation Between C_p and C_v

Consider one mole of ideal gas enclosed in a cylinder of initial volume (V) and initial pressure (P).

The gas is first heated at constant volume so that its temperature increases by ΔT .

Let the heat supplied be ΔQ .

$$\Delta Q = \Delta U$$

$$\text{i.e. } \Delta U = C_v \Delta T \text{ ————— (1)}$$

*Internal energy only depends on temperature.

One mole of the same gas is then heated at constant pressure so that its temperature increases by ΔT on being supplied heat ($\Delta Q'$).

From definition :

$$\Delta Q' = C_p \Delta T \text{ ————— (2)}$$

The heat supplied ($\Delta Q'$) is used for increasing temperature of gas by ΔT and doing external work (ΔW) due to expansion of gas. According to 1st law of thermodynamics (conservation of energy)

$$\Delta Q' = \Delta U + \Delta W \text{ ————— (3)}$$

Using equation (1) and (2) in equation (3), we have ,

$$C_p \Delta T = C_v \Delta T + P \Delta V \quad (\text{Work done } (\Delta W) = P \Delta V)$$

ΔV is increase in volume.

$$C_p \Delta T = C_v \Delta T + P \Delta V \text{ ————— (4)}$$

The ideal gas equation for 1 mole of gas is ,

$$PV = RT \text{ [n=1] ————— (5)}$$

$$\text{Or } P(V + \Delta V) = R(T + \Delta T) \text{ ————— (6)}$$

Subtracting (5) from (6),

$$P(V + \Delta V) - PV = R(T + \Delta T) - RT$$

$$\text{Or } P \Delta V = R \Delta T \text{ ————— (7)}$$

Using equation (7) in equation (4), we get,

$$C_p \Delta T = C_v \Delta T + R \Delta T$$

$$\text{Or } C_p = C_v + R$$

$$\text{Or } C_p - C_v = R \text{ —————} \rightarrow \text{Also called } \textit{Mayer's Relation}.$$

Thermal Conductivity

Introduction

Transfer of heat from one end (part) to another end (part) by molecular collisions (without movement of particles from their original position) is called conduction.

OR

Transfer of heat from the place of higher temperature to the place of lower temperature due to molecular vibration of particles about their mean position (without their actual motion) is called conduction.

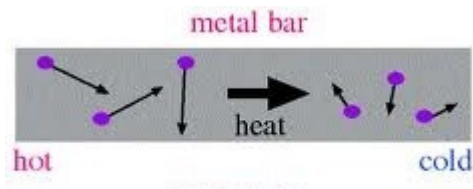

Thermal Conductivity or Co-efficient of Thermal Conduction

The ability of a solid (material) to transfer or conduct heat is called *thermal conductivity or co-efficient of thermal conduction*

Formula for Thermal Conductivity (K) of a solid

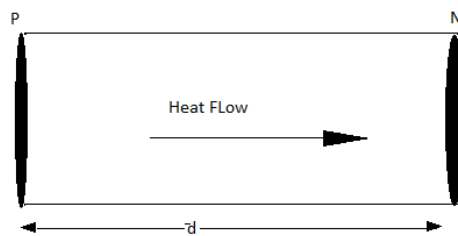

Solid cylindrical object with uniform cross-section

θ_1 —→ Temperature of face P

θ_2 —→ Temperature of face N

Q —→ Heat flow from face P to face N

d \longrightarrow Distance between the faces

A \longrightarrow Area of the face

t \longrightarrow Time of heat flow from face P to face N

Quantity of heat flow depends on the following factors :

a) $Q \propto A$ (Area of face)

b) $Q \propto (\theta_1 - \theta_2)$ (Temperature difference between the faces)

c) $Q \propto t$ (Time of heat flow)

d) $Q \propto \frac{1}{d}$ (Distance between the faces)

Combining the above expressions,

$$Q \propto (\theta_1 - \theta_2) t \frac{1}{d}$$

$$\text{Or, } Q = KA (\theta_1 - \theta_2) t \frac{1}{d},$$

$K \rightarrow$ Proportionality constant called Thermal Conductivity of solid material

$$K = Q d / A (\theta_1 - \theta_2) t$$

Definition of Thermal Conductivity (K) \rightarrow

Thermal conductivity of a solid (material) is defined as the quantity of heat flowing in one second between the opposite faces of a unit cube or an unit cylinder, the temperature difference between the opposite faces being unit degree (1°C or 1°K or 1°F)

In the expression for K,

$$K = Q d / A (\theta_1 - \theta_2) t, \text{ if } A = 1 \text{ m}^2, d = 1 \text{ m}, (\theta_1 - \theta_2) = 1^\circ$$

$$1^\circ, = 1 \text{ sec}$$

$$h, =$$

$$\text{Unit of } K \rightarrow K = Q d / A (\theta_1 - \theta_2) t \rightarrow \text{Joule} \times \text{m} / \text{m}^2 \times ^\circ \text{K} \times \text{sec}$$

$$= \text{Joule} \text{ m}^{-1} \cdot \text{K}^{-1} \text{ sec}^{-1} = \text{Watt} \text{ m}^{-1} \cdot \text{K}^{-1}$$

Dimension of K :-

$$K = Q d / A (\theta_1 - \theta_2) t \rightarrow \text{M}^1 \text{L}^2 \text{T}^{-2} \times \text{L} / \text{L}^2 \times \text{K} \times \text{T} = \text{M}^1 \text{L}^1 \text{T}^{-3} \text{K}^{-1}$$

UNIT – 6

OPTICS

Optics

Refractive Index of a Medium (μ)

It is the ratio of sine of the angle of incidence to the sine of angle of refraction.

$$\mu = \frac{\sin i}{\sin r}$$

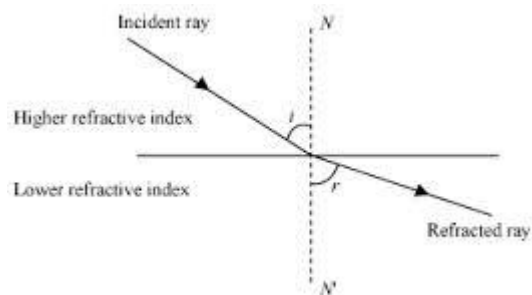
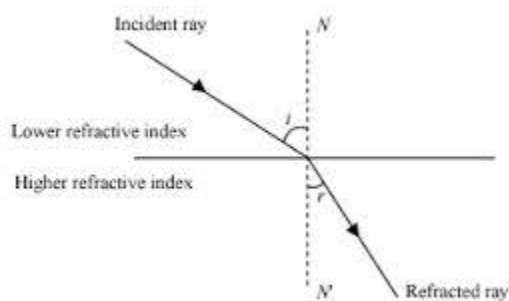

Refractive index is also defined as ratio of velocity of light in air to the velocity of light in the medium.

$$\mu = \frac{\text{Velocity of light in air}}{\text{Velocity of light in the medium}}$$

Unit of μ

It is a ratio and has no unit.

Salient Points

- Greater the refractive index of a medium, smaller is the velocity of light in it.
- Smaller the refractive index of a medium, greater is the velocity of light in it.
- A medium with higher value of refractive index is called optical denser medium.
- A medium with lower value of refractive index is called optical rarer medium.
- $(\text{Refractive Index})_{\text{medium}} = (\text{Absolute Refractive Index})_{\text{medium}}$

- (Refractive Index)_{air} = 1.003

$$(\text{Refractive Index})_{\text{vacuum}} = 1$$

$$\text{Hence, } (\text{Refractive Index})_{\text{air}} = (\text{Refractive Index})_{\text{vacuum}} = 1$$

Numerical Example

Velocity of light in vacuum is 3×10^8 m/sec. Find out velocity of light in glass having refractive index 1.5 .

Solution) $\mu = \frac{\text{Velocity of light in air}}{\text{Velocity of light in the medium}}$

$$\text{Or } \frac{3 \times 10^8}{\text{velocity of light in glass}} = 1.5$$

$$\text{Or Velocity of light in glass} = 3 \times 10^8 / 1.5 = 2 \times 10^8$$

Refraction through a prism

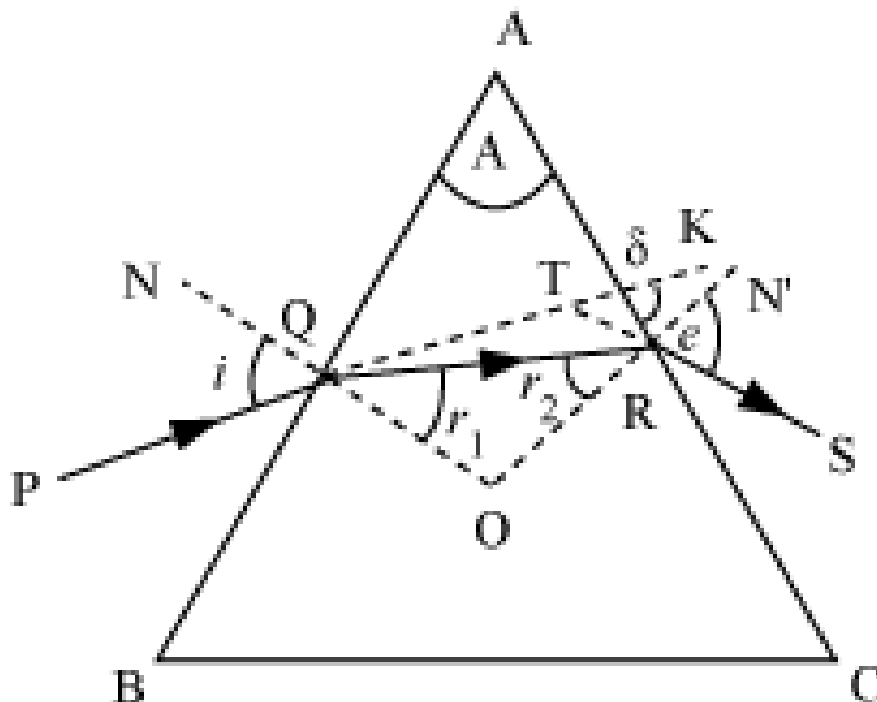

i = Angle of incidence

e = Angle of emergence

From the diagram it is clear that, In the quadrilateral AQOR,

$$\angle QOR + \angle QAR = 180^\circ = \angle r_1 + \angle r_2 + \angle QOR$$

i.e $\angle QAR = \angle r_1 + \angle r_2$, or $\angle A = \angle r_1 + \angle r_2$

In the position of minimum deviation

$$\angle i = \angle e \text{ and } \angle r_1 = \angle r_2 = \angle r$$

$$i = \frac{A + D_m}{2} \text{ and } r = \frac{A}{2}$$

Using the formula for Refractive Index,

$$\mu = \frac{\sin i}{\sin r} = \frac{\sin(A + D_m)/2}{\sin A/2}$$

TOTAL INTERNAL REFRACTION :-

DEFINITION:- It is the phenomenon in which a ray of light travelling from denser to rarer medium is reflected back into the incident medium(denser medium)if the angle of incidence is greater than the critical angle.

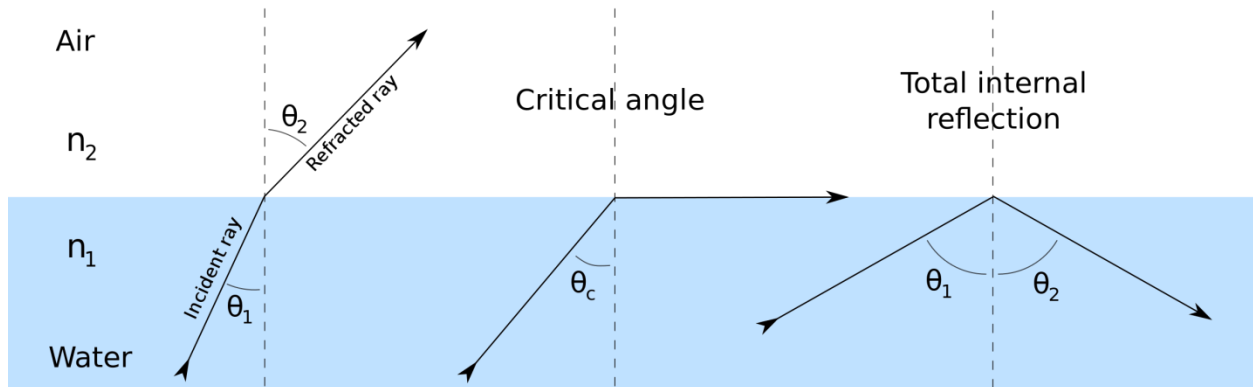

When $\theta_1 < \theta_c$, then refraction occurs.

And when $\theta_1 > \theta_c$ total internal reflection occurs.

This only happens when light travels from optically denser to rarer medium.

Conceptual Points

- When a light ray travels from denser to rarer medium, the refracted ray bends away from the normal. The angle of refraction is greater than the angle of incidence.
- The angle of refraction increases with increase in the angle of incidence. For a particular angle of incidence, the angle of refraction becomes equal to 90° . This angle of incidence is called *critical angle*.
- When the angle of incidence exceeds the critical angle, the incident light ray instead of being refracted gets reflected back into the rarer medium (incident medium).

This phenomenon is called *total internal reflection*

The conditions under which total internal reflection occurs:-

- (a) The light ray should travel from denser medium to rarer medium.
- (b) The angle of incidence in the denser medium (incident medium) must be greater than the critical angle.

Critical Angle (i_c or c or θ_c)

The angle of incidence in the denser medium (incident medium) for which the angle of refraction is 90° in the rarer medium is called critical angle (θ_c).

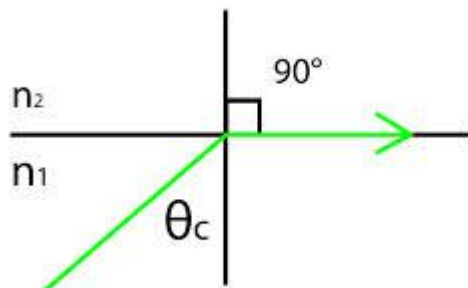

Here, $n_1 > n_2$ or, $\mu_1 > \mu_2$

Relation between ' μ ' and ' C ':-

μ_1 → Refractive Index of Denser (Incident) Medium

μ_2 → Refractive Index of Rarer Medium

C → Critical Angle in the Denser (Incident) Medium

By definition, $\mu = \frac{\sin i}{\sin r}$

When light travels from denser to rarer medium, $\mu_2 = \frac{\sin C}{\sin 90^\circ} = \sin C$

Hence $\mu_1 = \frac{\sin 90^\circ}{\sin C} = \frac{1}{\sin C}$

$\Rightarrow C = \sin^{-1} \frac{1}{\mu_1}$

APPLICATIONS OF TOTAL INTERNAL REFLECTION

Hot Mirage (Mirage) or Inferior Image :-

It is an optical illusion due to which a traveller in a desert or a very hot place gets the impression of presence of a pool of water from a distance.

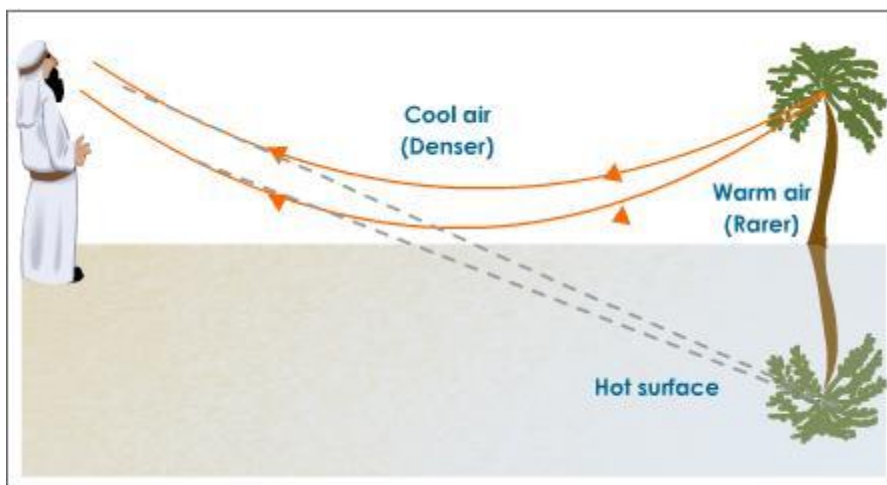

Explanation :-

In deserts the air near the ground is hotter and of lower density. Air at a height above the ground is relatively less hot and of higher density. Light

rays starting from a tree passes successively from denser to rarer medium. The refracted rays bend away from the normal and the angle of incidence gradually increases. When angle of incidence goes above the critical angle, total internal reflection occurs and the light ray is reflected back. Hence a virtual image of the object is seen by the person, which conveys the illusion of reflection of object in water.

COLD MIRAGE (LOOMING) or SUPERIOR MIRAGE:-

It is an optical illusion occurs in a cold due to which a traveller in a very cold place gets the impression of objects (ship) from a large distance floating in the air.

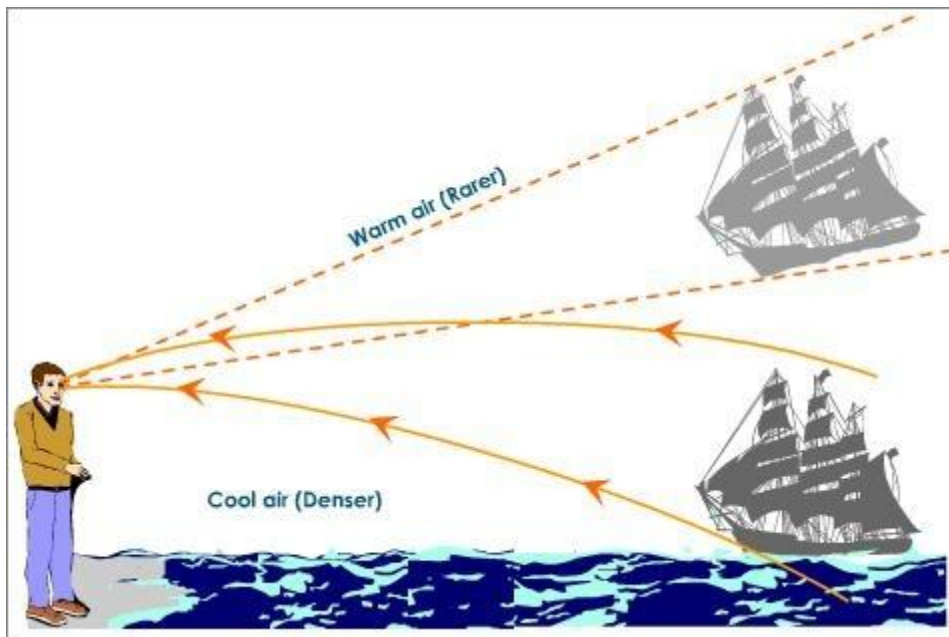

In cold or polar regions, air at lower level is comparatively cooler (denser) than the air at higher levels (rarer). Hence a beam of light coming from a ship travels from denser to rarer medium and the angle of incidence goes on increasing with each layer of air. When the angle of incidence exceeds the critical angle, the light ray gets reflected back due to total internal reflection. Hence the observer looking straight sees the virtual image of the ship appears to be floating in the air. This optical illusion is called **LOOMING** or **Superior Mirage**.

FIBRE OPTICS

- **Fibre Optics** is a technology related to transportation of Optical Energy (Light energy) through specifically designed Optical Fibres.
- **Optical Fibres** are glass fibres of diameters 02 microns (2×10^{-6} mt) are bundled together to prepare an Optical Fibre.

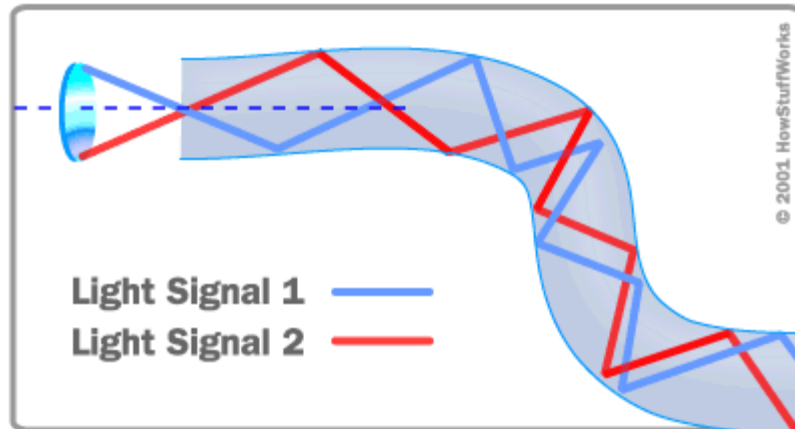

Conceptual Expansion:-

- Light Energy propagates through the fibres by multiple total internal reflections. The inner part i.e **CORE** is optically denser (higher refractive index). Outer part i.e **CLADDING** surrounding the core has lesser optical density (lesser refractive index).
- Each fibre is optically insulated by coating with a material having less refractive index than the fibre.
- Light ray entering at one end of the cable undergoes multiple (Successive) total internal reflections, because the angle of incidence is always greater than the critical angle. Consequently light is transmitted to the other end without loss of intensity (Energy)

APPLICATIONS OF OPTICAL FIBRES :-

- Optical fiber can be used as a medium for telecommunication and [computer networking](#) because it is flexible and can be bundled as [cables](#). It is especially advantageous for long-distance communications, because light propagates through

the fiber with little attenuation compared to electrical cables. This allows long distances to be spanned with few [repeaters](#).

- Optical fibers can be used as sensors to measure [strain](#), [temperature](#), [pressure](#) and other quantities by modifying a fiber so that the property to measure modulates the [intensity](#), [phase](#), [polarization](#), [wavelength](#), or transit time of light in the fiber
- Optical fibers have a wide number of applications. They are used as [light guides](#) in medical and other applications where bright light needs to be shone on a target without a clear line-of-sight path.
- In some buildings, optical fibers route sunlight from the roof to other parts of the building.
- [Optical fiber lamps](#) are used for illumination in decorative applications, including [signs](#), [art](#), toys and artificial [Christmas trees](#).
- Optical fiber is an intrinsic part of the light-transmitting concrete building product,
- Optical fiber is also used in imaging optics. A coherent bundle of fibers is used, sometimes along with lenses, for a long, thin imaging device called an [endoscope](#), which is used to view objects through a small hole. Medical endoscopes are used for minimally invasive exploratory or surgical procedures. Industrial endoscopes are used for inspecting anything hard to reach, such as jet engine interiors. Many [microscopes](#) use fiber-optic light sources to provide intense illumination of samples being studied.

UNIT -7

MAGNETOSTATICS

AND ELECTROSTATICS

Magnetostatics

Fundamental concepts

- (a) A substance which attracts pieces of iron and steel is called a magnet.
- (b) The property of attracting or repelling is called magnetism.
- (c) Bar magnet is the simplest form of magnet. It has two poles-North pole and South pole.
- (d) Both poles of magnet are of equal strength.
- (e) Like poles repel each other and unlike poles attract each other.
- (f) Iron, steel, nickel are magnetic substances and can be converted into magnets.
- (g) 'm'-symbol used to denote Pole strength.
- (h) SI unit of pole strength is ampere meter or weber.

Magnetic field

The space surrounding a magnetic pole within which the magnetic effects of pole can be felt is called magnetic field.

Coulomb's Laws in Magnetism :-

The force of attraction or repulsion between two magnetic poles is directly proportional to the product of their pole strengths and inversely proportional to the square of distance between them.

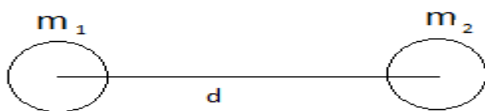

m_1 = Pole strength of 1st pole

m_2 = Pole strength of 2nd pole

d = Distance between the poles

F = Force of attraction or repulsion between the poles

According to the statement of Coulomb's law,

$$F \propto m_1 m_2$$

$$F \propto \frac{1}{d^2} \Rightarrow F \propto \frac{1}{d^2} \Rightarrow F = K \frac{1}{d^2},$$

K = Proportionality constant which depends upon the surrounding

medium and system of units chosen.

In SI system,

$K = \frac{\mu}{\mu_0}$, (μ = Permeability of medium between the poles)

$$F = \frac{\mu}{4\pi} \frac{q_1 q_2}{r^2} ,$$

$\mu_0 = 4\pi \times 10^{-7} \text{ Tm/A}$, μ_0 = Permeability of free space or air,

$\mu_r = \frac{\mu}{\mu_0}$ = Relative permeability of the medium

$$F = \frac{\mu_r}{4\pi} \frac{q_1 q_2}{r^2} ,$$

When the medium between the poles is air,

$$= 1 \Rightarrow = \dots \Rightarrow F = \frac{q^2}{4\pi\epsilon_0 r^2},$$

$$q = 4 \times 10^{-7} \text{ C} \Rightarrow \frac{q^2}{4\pi\epsilon_0 r^2} = 10^{-7} \text{ N}$$

UNIT POLE :-

Unit pole is a pole of that much strength which when placed at a

distance of 1m from a similar pole repels it with a force of $\frac{1}{4\pi\epsilon_0}$ Newton or

10^{-7} Newton.

Definition of Weber:- One Weber is a pole of that much strength which

when placed at a distance of 1m from a similar pole repels it with a force of

$\frac{\mu_0}{4\pi}$ Newton or 10^{-7} Newton.

MAGNETIC FIELD INTENSITY (H) :- Magnetic field intensity at any point within a magnetic field is the force experienced by a unit north pole placed at that point.

F = Force experienced by a pole of strength m weber

Hence H = Force experienced by a unit pole = $\frac{F}{m}$ (SI Unit)

From Coulomb's laws in magnetism, $F = \frac{\mu_0}{4\pi} \frac{m_1 m_2}{r^2}$,

If, $m_1 = m$ weber, $m_2 = 1$

$$\text{Then, } F = H = \frac{B}{\mu_0}$$

is a vector quantity. The direction of H is the direction in which a unit north pole would move if it were free to do so.

MAGNETIC LINES OF FORCE :- These are imaginary closed curves drawn in a magnetic field such that the tangent drawn at any point of the curve gives the direction of resultant magnetic field at that point.

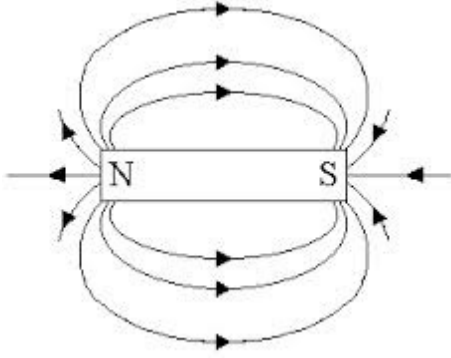

Lines of force start from N- pole and ends on S-pole outside the magnet

but start from S- pole and ends on N-pole inside the magnet.

Unit Pole $\Rightarrow \mu = 4 \times 10^{-7}$ lines of force are associated.

Pole of m weber $\Rightarrow m \mu$ lines of force are associated

MAGNETIC FLUX :- Magnetic flux deals with the study of no. of lines of

force of magnetic field crossing a certain area.

Let, A = area of the coil placed in the magnetic field

B = Magnetic Flux density

θ = Angle between B and the normal to area A

The Area in vector notation can be represented by a vector directed

along the normal to the area and having a length proportional to the

magnitude of the area.

Magnetic Flux through the area is given by, $\Phi = \int \mathbf{B} \cdot \mathbf{A} = BA \cos \theta = A(B \cos \theta)$

$B \cos \theta$ = component of B perpendicular to the area A

Magnetic Flux linked with a surface is defined as the product of area and the

component of B perpendicular to the area.

Unit of Flux:- Weber (SI Unit)

Maxwell (CGS Unit)

1 Weber = 10^8 Maxwell

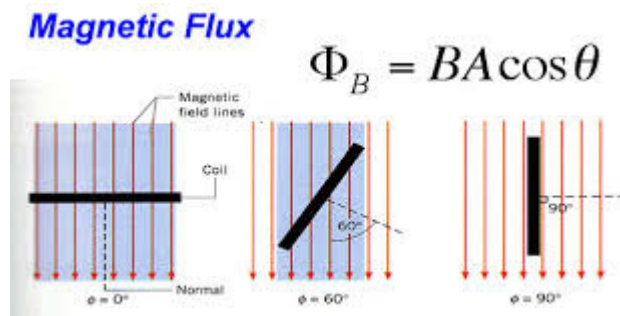

i) When $\theta = 0^\circ$, i.e the coil is held perpendicular to the magnetic

field and the normal to the coil is parallel to the magnetic field,

$$\Phi = BA$$

ii) When $\theta = 60^\circ$, i.e. the normal to the coil is held at 60° to the

magnetic field, $\Phi = BA \cos 60^\circ$

iii) When $\theta = 90^\circ$, i.e. coil is held parallel to the magnetic field and

the normal to the coil is held at 90° to the magnetic field,

$$\Phi = B A \cos 90^\circ = 0$$

MAGNETIC FLUX DENSITY B :-

It is defined as the magnetic flux crossing unit area, when the area is held perpendicular to the magnetic field.

$$B = \frac{\Phi}{A}, \text{ Unit of } B = \frac{\text{Wb}}{\text{m}^2} = \text{Tesla (SI Unit)}$$

CGS Unit of B = Gauss, 1 Tesla = 10^4 Gauss

ELECTROSTATICS

- Electrostatics is the study of electrical effects of charges at rest.
- Charge is the property associated with matter due to which it produces electrical and magnetic effects.
- Unit of charge – CGS → Electrostatic unit → Stat- Coulomb

Electromagnetic unit → ab- Coulomb

SI → Coulomb

1 Coulomb = $1/10$ ab- Coulomb

= 3×10^9 Stat- Coulomb

PROPERTIES OF CHARGE :-

- Charge is a scalar quantity.
- Charge is quantized. i.e. Charge on any body will be an integral multiple of e (elementary charge) i.e $q = \pm ne$, where, $n = 1, 2, 3$ etc.
- Charge can neither be created or destroyed.
- Charge on 1 proton/ electron = 1.6×10^{-19} Coulomb
- Like or similar charges repel and unlike or opposite charges attract each other.

- No. of electrons present in one coulomb of charge →

$$= \frac{1}{1.6 \times 10^{-19}} = 6.25 \times 10^{18}$$

Electric field

The space surrounding an electric charge within which the electric effects can be felt is called electric field.

Coulomb's Laws in Electrostatics :-

The force of attraction or repulsion between two point charges is directly proportional to the product of their charges and inversely proportional to the square of distance between them.

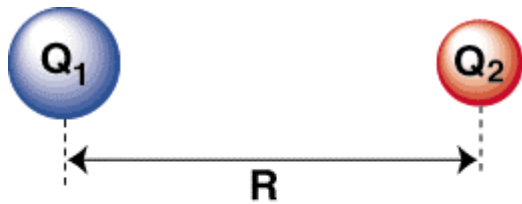

$$E = \frac{kQ_1Q_2}{R^2}$$

Q_1 = Magnitude of 1st charge

Q_2 = Magnitude of 2nd charge

R = Distance between the charges

F = Force of attraction or repulsion between the charges

According to the statement of Coulomb's law,

$$F \propto Q_1 Q_2$$

$$F \propto \frac{1}{r^2} \Rightarrow F \propto \frac{1}{r^2} \Rightarrow F = K \frac{1}{r^2},$$

K = Proportionality constant which depends upon the surrounding

medium and system of units chosen.

In SI system,

$$K = \frac{1}{4\epsilon_0}, \quad (\epsilon_0 = \text{Permittivity of medium between the charges})$$

$$F = \frac{1}{4\pi\epsilon_0} \frac{q_1q_2}{r^2}, \quad \epsilon_0 = \text{Permittivity of free space or air,}$$

ϵ_r = Relative Permittivity of the medium

$$F = \frac{1}{4\pi\epsilon_r\epsilon_0} \frac{q_1q_2}{r^2},$$

When the medium between the two charges is air,

$$\epsilon_r = 1 \Rightarrow \epsilon = \epsilon_0 \Rightarrow F = \frac{1}{4\pi\epsilon_0} \frac{q_1q_2}{r^2},$$

$$\epsilon_0 = 8.854 \times 10^{-12} \frac{\text{C}^2}{\text{N}\cdot\text{m}^2} \text{ or, } \epsilon_0 = 8.854 \times 10^{-12} \frac{\text{C}^2}{\text{N}\cdot\text{m}^2}$$

$$\text{Thus, } \frac{1}{4\pi\epsilon_0} = \frac{1}{4 \times 8.854 \times 10^{-12}} = 9 \times 10^9 \frac{1}{\text{m}^2}$$

UNIT CHARGE :-

Unit charge is a charge of that much strength which when placed at a

distance of 1m from a similar charge repels it with a force of $\frac{1}{4\pi\epsilon_0}$ Newton

or 9×10^9 Newton.

ELECTRIC FIELD INTENSITY (E):- Electric field intensity at any point within an electric field is the force experienced by a unit charge placed at that point.

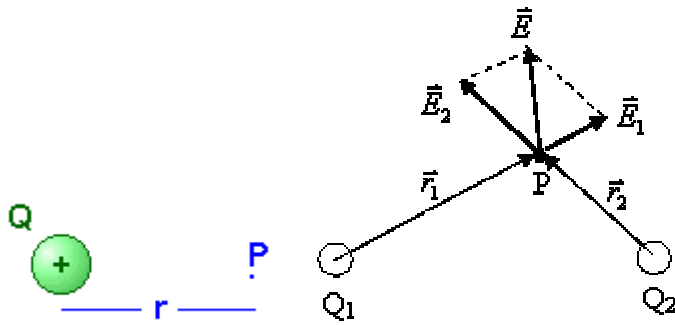

Let, F = Force experienced by the test charge at point P

E = Electric Field Intensity at point P

q = Test charge placed at P

Force experienced by the test charge $q = F$

\Rightarrow Force experienced by a unit charge = $E = \frac{F}{q} = \frac{F}{1} = F$

From Coulomb's laws in electrostatics, $F = F = \frac{1}{4\pi\epsilon_0} \frac{q_1 q_2}{r^2}$,

Let, $q_1 = q_2 = 1$

= 1 = Unit Charge at point P

d = Distance of the point from the parent charge

$$\text{Then, } F = E = \frac{1}{4\pi\epsilon_0} \frac{q}{d^2} \hat{r}$$

$$\text{For, air medium, } \epsilon_r = 1 \Rightarrow E = \frac{1}{4\pi\epsilon_0} \frac{q}{d^2} = 9 \times 10^9 \frac{q}{d^2}$$

is a vector quantity. The direction of \hat{r} is the direction in which a unit charge would move if it were free to do so.

ELECTROSTATIC POTENTIAL

Definition:-

Electrostatic potential at a point within an electric field is the work done in moving a unit positive charge (test charge) from infinity to that point (against the field).

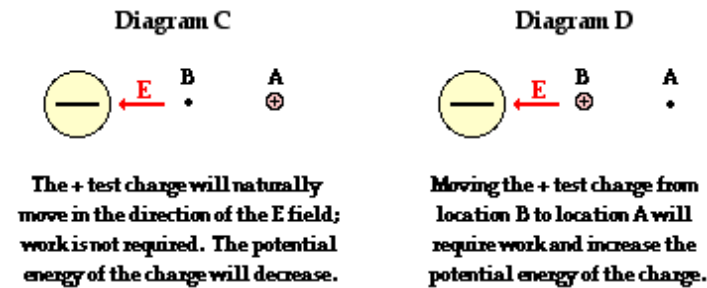

Let, Q = Parent charge which produces electric field,

q = Test charge (+ve) moved from ∞ to A.

W= work done in moving test charge from ∞ to A.

V= Electric potential at point A

For moving charge q from ∞ to A, work done is =W

Hence, for moving unit(+1) charge from ∞ to A, work done is = $W = V$

$$V = \frac{W}{q}$$

V is a scalar quantity.

Unit of V :- $V = \frac{W}{q} = \frac{\text{Joule}}{\text{Coulomb}} = \text{J C}^{-1}$ (SI Unit)

$V = \frac{W}{q} = \frac{\text{erg}}{\text{esu}} = \text{esu}^{-1}$ (CGS Unit), 1Stat volt= 300 volt

Dimension of V :- $V = \frac{W}{q} = \frac{ML^2T^{-2}I^{-1}}{IT} = ML^2T^{-2}I^{-2} = \text{A}^{-1}$

CAPACITY OF A CONDUCTOR:-

DEFINITION:-

Capacity of a conductor is defined as the amount of charge given to raise its electric potential by unity.

Let, Q = Charge supplied to the conductor

V = Rise in potential of conductor

C = Capacity of the conductor

Potential of V volt is raised by Q coulomb of charge

Hence, Potential of 1 volt is raised by _____ coulomb of charge

Thus, Capacity of the conductor = $C = \frac{Q}{V}$

Unit of C :- $C = \frac{C}{V} = \frac{C}{J/C} = C^2/J$ (SI Unit)

$C = \frac{C}{V} = \frac{C}{erg/C} = \frac{C^2}{erg}$ (CGS Unit),

1 FARAD = 9×10^{11} Stat- farad

For practical purposes smaller units like millifarad(mF), microfarad (μF), picofarad (pF) are used.

1 mF = 10^{-3} Farad

1 μF = 10^{-6} Farad

1 pF = 10^{-12} Farad

CAPACITY OF A CAPACITOR:-

- i) **A combination of two conducting** surfaces or conductors separated by a fixed distance with an insulating or dielectric medium in between is called Capacitor or Condenser.

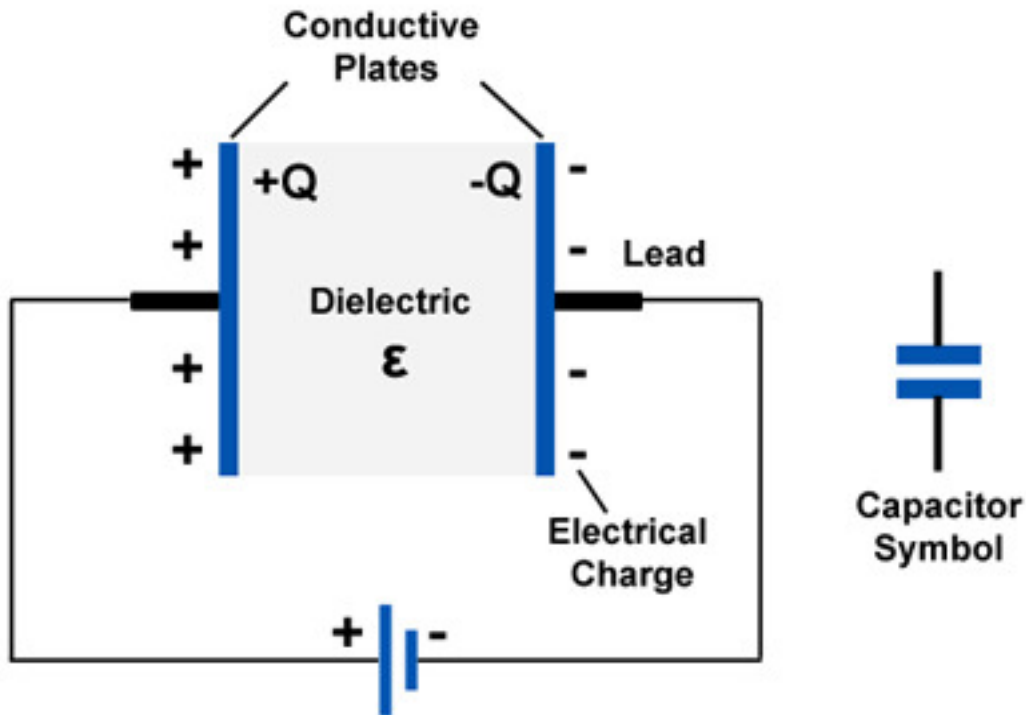

- ii) The two conductors of the capacitor have charges equal in magnitude and opposite sign. Thus the net charge on the capacitor as a whole remains zero.
- iii) A capacitor stores energy as Potential Energy in the Electric Field.

CAPACITY OF A PARALLEL PLATE CAPACITOR

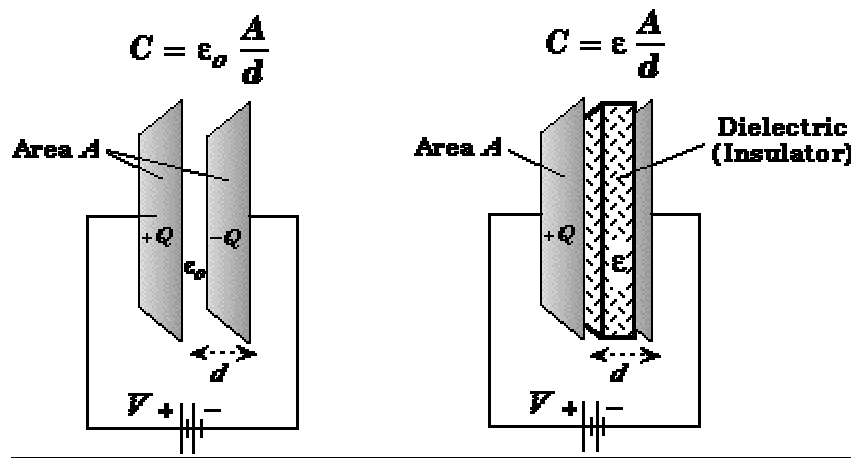

A Parallel Plate Capacitor consists of two parallel metal plates separated by a fixed distance and the space/ medium between the plates may be air, mica, glass or paper (Dielectrics).

Let, $A \rightarrow$ Area of each Plate

$d \rightarrow$ Distance between the plates

$V \rightarrow$ Potential Difference across the plates

$Q \rightarrow$ Charge on each Plate

\rightarrow Surface charge density on either plate = σ

$E \rightarrow$ Electric field intensity

$\epsilon \rightarrow$ Permittivity of the medium

From definition, we know that, $E = \frac{Q}{\epsilon A} = \frac{\sigma}{\epsilon}$

Also, $E = \frac{V}{d} \Rightarrow V = E d$

Putting the value of E , we have, $V = \frac{Q}{\epsilon A} d \Rightarrow \sigma = \frac{\epsilon V}{d}$

Hence, Capacitance = $C = \frac{Q}{V} = \frac{\epsilon V A}{d V} = \frac{\epsilon A}{d}$

, $\epsilon = \epsilon_0 \epsilon_r$ relative permittivity or dielectric constant of the medium

When the dielectric medium between the plates is air, then $\epsilon_r = 1$

Hence, $C = \frac{\epsilon_0 A}{d}$

Effect of Dielectric on Capacity:-

- i) Capacity of a capacitor increases ϵ_r times on introduction of a dielectric other than air.
- ii) The value of Dielectric constant of a medium is always greater than 1.

- iii) Presence of Dielectric decreases potential difference between the plates leading to increase in capacitance.

GROUPING OF CAPACITORS IN PARALLEL :-

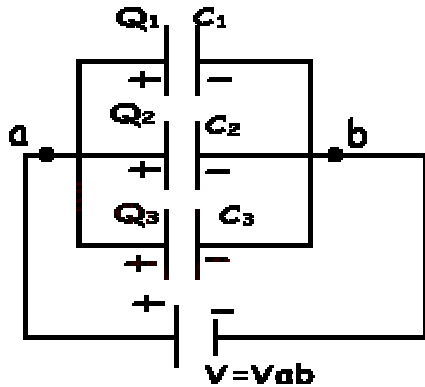

Let, $Q_1 =$ Charge on C_1

$Q_2 =$ Charge on C_2

$Q_3 =$ Charge on C_3

$Q =$ Total Charge in the Circuit

$$Q = Q_1 + Q_2 + Q_3$$

As the three capacitors are connected across the common terminals A and B, the potential difference across each is same.

i.e $Q_1 = C_1V$, $Q_2 = C_2V$, $Q_3 = C_3V$, $Q = CV$

$$\text{Hence, } Q = Q_1 + Q_2 + Q_3 \Rightarrow CV = C_1V + C_2V + C_3V \Rightarrow \mathbf{C = C_1 + C_2 + C_3}$$

Thus, when capacitors are connected in parallel, the equivalent capacity in the combination of the capacitors is the sum of the individual capacitances.

GROUPING OF CAPACITORS IN SERIES :-

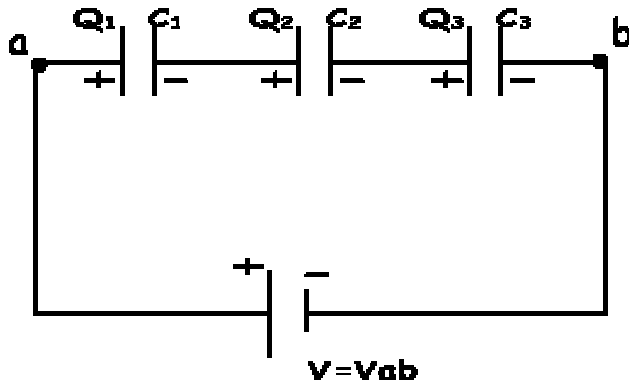

Let, V_1 = Potential difference across C_1

V_2 = Potential difference across C_2

V_3 = Potential difference across C_3

V = Potential difference across the circuit

In series combination the charge across each capacitor is same and equal to Q i.e $Q_1 = Q_2 = Q_3 = Q$ and the Potential difference across the circuit is equal to the sum of potential differences across each capacitor.

$$\text{Hence, } V = V_1 + V_2 + V_3$$

$$V = \frac{Q}{C}, \quad V_1 = \frac{Q}{C_1}, \quad V_2 = \frac{Q}{C_2}, \quad V_3 = \frac{Q}{C_3}$$

Thus, we have,

$$\frac{Q}{C} = \frac{Q}{C_1} + \frac{Q}{C_2} + \frac{Q}{C_3} \Rightarrow \frac{1}{C} = \frac{1}{C_1} + \frac{1}{C_2} + \frac{1}{C_3}$$

Hence, when capacitors are connected in series, the reciprocal of equivalent capacity is equal to the sum of reciprocals of individual capacitances.

UNIT-8

CURRENT

ELECTRICITY

&

ELECTROMAGNETISM

INTRODUCTION:-

In 1845, a German physicist, **Gustav Kirchoff** developed a set of laws which deal with the conservation of current and energy within [Electrical Circuits](#). These two rules are commonly known as: *Kirchoffs Circuit Laws* with one of Kirchoffs laws dealing with the current flowing around a closed circuit, **Kirchoffs Current Law, (KCL)** while the other law deals with the voltage sources present in a closed circuit, **Kirchoffs Voltage Law, (KVL)**.

Kirchoffs First Law – The Current Law, (KCL)

Kirchoffs Current Law or KCL, states that the “*total current or charge entering a junction or node is exactly equal to the charge leaving the node as it has no other place to go except to leave, as no charge is lost within the node*“. In other words the algebraic sum of ALL the currents entering and leaving a node must be equal to zero, $I_{(\text{exiting})} + I_{(\text{entering})} = 0$.

This idea by Kirchoff is commonly known as the **Conservation of Charge**.

Kirchoffs Current Law

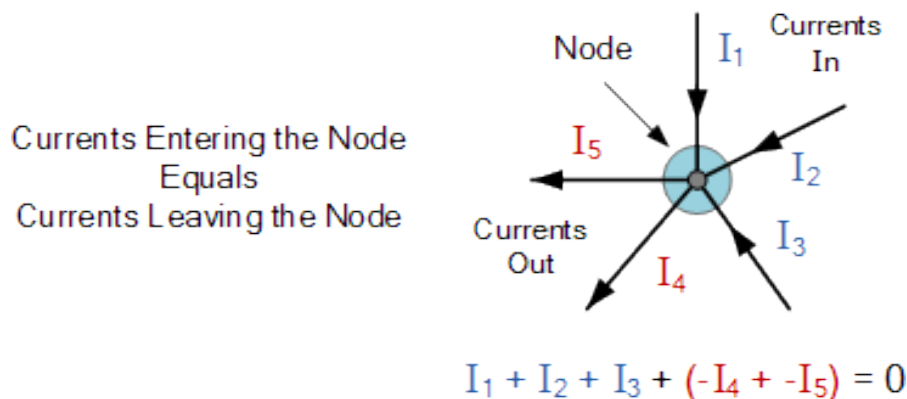

Here, the 3 currents entering the node, I_1, I_2, I_3 are all positive in value and the 2 currents leaving the node, I_4 and I_5 are negative in value. Then this means we can also rewrite the equation as;

$$I_1 + I_2 + I_3 - I_4 - I_5 = 0$$

The term **Node** in an electrical circuit generally refers to a connection or junction of two or more current carrying paths or elements such as cables and components. Also for current to flow either in or out of a node a closed circuit path must exist. We can use Kirchoff's current law when analysing parallel circuits.

Kirchoffs Second Law – The Voltage Law, (KVL)

Kirchoffs Voltage Law or KVL, states that “*in any closed loop network, the total voltage around the loop is equal to the sum of all the voltage drops within the same loop*” which is also equal to zero. In other words the algebraic sum of all voltages within the loop must be equal to zero. This idea by Kirchoff is known as the **Conservation of Energy**.

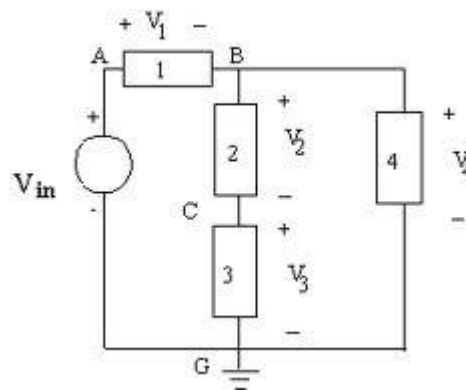

As per Kirchoff's voltage law, $\sum V=0$ about each closed loop. So keeping reference polarities in mind we can get three equations for the three loops,

$$V_{in} - V_1 - V_2 - V_3 = 0 \quad (\text{Eq. 1})$$

$$V_3 + V_2 - V_4 = 0 \quad (\text{Eq. 2})$$

$$V_{in} - V_1 - V_4 = 0 \quad (\text{Eq. 3})$$

Starting at any point in the loop continue in the **same direction** noting the direction of all the voltage drops, either positive or negative, and returning back to the same starting point. It is important to maintain the same direction either clockwise or anti-clockwise or the final voltage sum will not be equal to zero. We can use Kirchoff's voltage law when analysing series circuits.

When analysing either DC circuits or AC circuits using **Kirchoffs Circuit Laws** a number of definitions and terminologies are used to describe the parts of the circuit being analysed such as: node, paths, branches, loops and meshes. These terms are used frequently in circuit analysis so it is important to understand them.

Common DC Circuit Theory Terms:

- **Circuit** – a circuit is a closed loop conducting path in which an electrical current flows.
- **Path** – a single line of connecting elements or sources.
- **Node** – a node is a junction, connection or terminal within a circuit where two or more circuit elements are connected or joined together giving a connection point between two or more branches. A node is indicated by a dot.
- **Branch** – a branch is a single or group of components such as resistors or a source which are connected between two nodes.
- **Loop** – a loop is a simple closed path in a circuit in which no circuit element or node is encountered more than once.
- **Mesh** – a mesh is a single open loop that does not have a closed path. There are no components inside a mesh.
 - Components are said to be connected in **Series** if the same current flows through component.
 - Components are said to be connected in **Parallel** if the same voltage is applied across them

A Typical DC Circuit

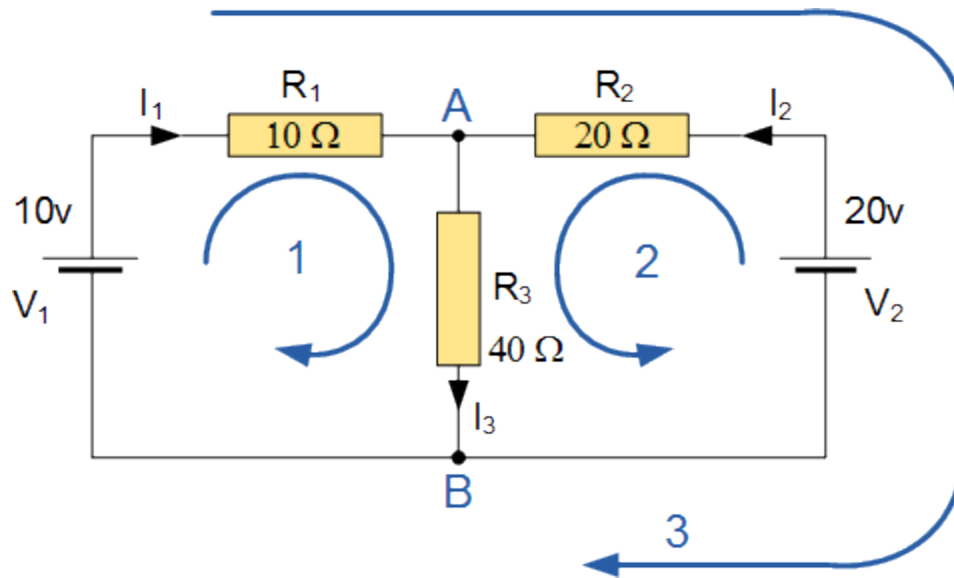

The circuit has 3 branches, 2 nodes (A and B) and 2 independent loops.

Using **Kirchoffs Current Law, KCL** the equations are given as;

$$\text{At node A : } I_1 + I_2 = I_3$$

$$\text{At node B : } I_3 = I_1 + I_2$$

Using **Kirchoffs Voltage Law, KVL** the equations are given as;

$$\text{Loop 1 is given as : } 10 = R_1 \times I_1 + R_3 \times I_3 = 10I_1 + 40I_3$$

$$\text{Loop 2 is given as : } 20 = R_2 \times I_2 + R_3 \times I_3 = 20I_2 + 40I_3$$

$$\text{Loop 3 is given as : } 10 - 20 = 10I_1 - 20I_2$$

Wheatstone Bridge

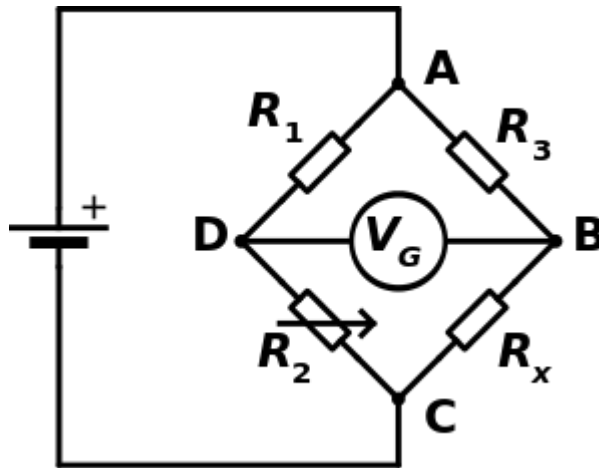

In the figure, R_x is the unknown resistance to be measured; R_1 , R_2 and R_3 are resistors of known resistance and the resistance of R_2 is adjustable. If the ratio of the two resistances in the known leg (R_2/R_1) is equal to the ratio of the two in the unknown leg (R_x/R_3), then the **voltage** between the two midpoints (B and D) will be zero and no **current** will flow through the **galvanometer** V_g . If the bridge is unbalanced, the direction of the current indicates whether R_2 is too high or too low. R_2 is varied until there is no current through the galvanometer, which then reads zero.

Detecting zero current with a **galvanometer** can be done to extremely high accuracy. Therefore, if R_1 , R_2 and R_3 are known to high precision, then R_x can be measured to high precision. Very small changes in R_x disrupt the balance and are readily detected.

At the point of balance, the ratio of

$$\frac{R_2}{R_1} = \frac{R_x}{R_3}$$
$$\Rightarrow R_x = \frac{R_2}{R_1} \cdot R_3$$

Derivation:

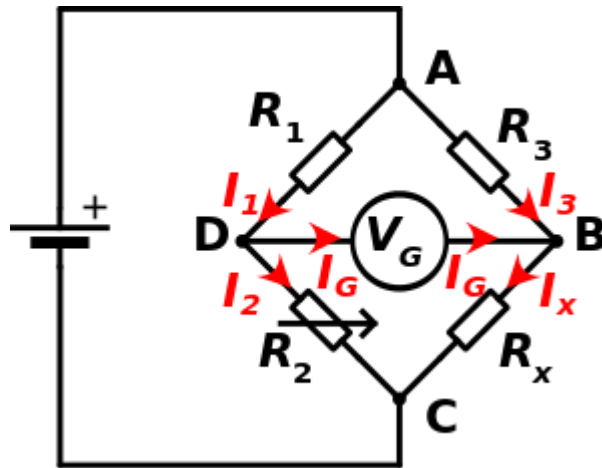

First, Kirchhoff's current law is used to find the currents in junctions B and D:

$$I_3 - I_x + I_G = 0$$

$$I_1 - I_2 - I_G = 0$$

Then, Kirchhoff's voltage law is used for finding the voltage in the loops ABD and BCD:

$$(I_3 \cdot R_3) - (I_G \cdot R_G) - (I_1 \cdot R_1) = 0$$

$$(I_x \cdot R_x) - (I_2 \cdot R_2) + (I_G \cdot R_G) = 0$$

When the bridge is balanced, then $I_G = 0$, so the second set of equations can be rewritten as:

$$I_3 \cdot R_3 = I_1 \cdot R_1$$

$$I_x \cdot R_x = I_2 \cdot R_2$$

Then, the equations are divided and rearranged, giving:

$$R_x = \frac{R_2 \cdot I_2 \cdot I_3 \cdot R_3}{R_1 \cdot I_1 \cdot I_x}$$

From the first rule, $I_3 = I_x$ and $I_1 = I_2$. The desired value of R_x is now known to be given as:

$$R_x = \frac{R_3 \cdot R_2}{R_1}$$

Biot-Savart law

Introduction :-

- An electric current flowing in a conductor, or a moving electric charge, produces a magnetic field.
- The value of the magnetic field at a point in the surrounding space may be considered the sum of all the contributions from each small element, or segment, of a current-carrying conductor.
- The Biot-Savart law states how the value of the magnetic field at a specific point in space from one short segment of current-carrying conductor depends on each factor that influences the field.

- The value of the magnetic field at a point is directly proportional to the value of the current (I) in the conductor.

$$dB \propto I$$

- **The value of the magnetic field at a point is directly proportional to the length(dl) of the current-carrying segment under consideration.**

$$dB \propto dl$$

- The value of the field depends also on the orientation of the particular point with respect to the segment of current . If the line from the point to the short segment of current makes an angle of 90° with the current segment or lies straight out from it, the field is greatest. As this angle gets smaller, the field of the current segment diminishes, becoming zero when the point lies on a line of which the current element itself is a segment.

$$dB \propto \sin\theta,$$

θ = Angle between the small current carrying element(dl) and the line connecting the element to point P (r)

- The magnetic field at a point depends upon how far the point is from the current element. **The value of the magnetic field is inversely proportional to the square of the distance from the current element that produces it.**

$$dB \propto \frac{1}{r^2}$$

- The magnitude of the magnetic field $d\mathbf{B}$ at a distance r from a current element $d\mathbf{l}$ carrying current I is found to be proportional to I , to the length $d\mathbf{l}$ and inversely proportional to the square of the distance $|r|$
- The direction of the magnetic Field is perpendicular to the line element $d\mathbf{l}$ as well as radius r
- Mathematically, Field $d\mathbf{B}$ is written as

$$d\mathbf{B} = \frac{\mu_0}{4\pi} I \frac{dl \sin\theta}{r^2}$$

In vector form it can be written as,

$$d\mathbf{B} = \frac{\mu_0}{4\pi} I \frac{d\mathbf{l} \times \vec{r}}{r^3}$$

Here $(\mu_0/4\pi)$ is the proportionality constant such that

$$\mu_0/4\pi = 10^{-7} \text{ Tesla Meter/Ampere (Tm/A)}$$

- Figure below illustrates the relation between magnetic field and current element

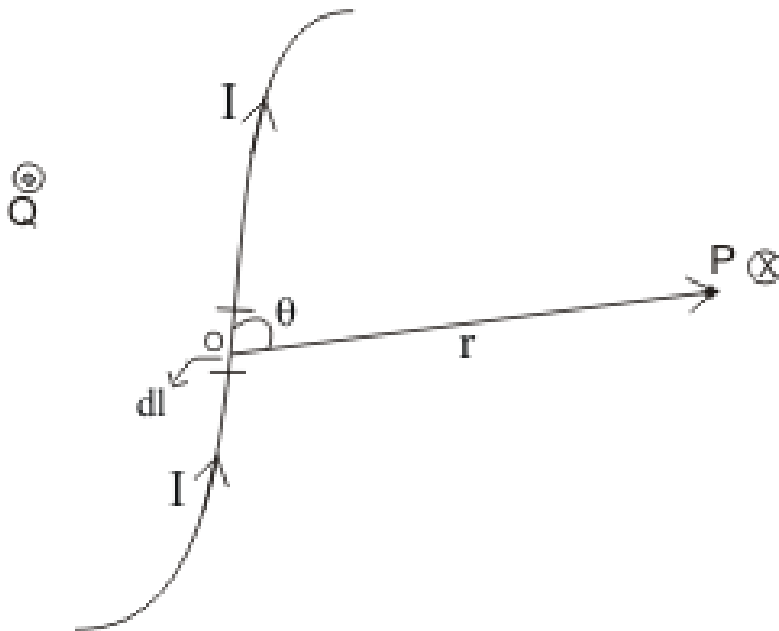

Figure 1. Field at point P is perpendicular to the plane of paper pointing into it

- In the figure, Consider that line element $d\mathbf{l}$ and radius vector \mathbf{r} connecting line element mid point to the field point P at which field is to be found are in the plane of the paper
- Magnetic field to be perpendicular to both $d\mathbf{l}$ and \mathbf{r} . Thus direction of $d\mathbf{B}$ is the direction of advance of right hand screw whose axis is perpendicular to the plane formed by $d\mathbf{l}$ and \mathbf{r} and which is rotated from $d\mathbf{l}$ to \mathbf{r} (right hand screw rule of vector product)
- Thus in figure , $d\mathbf{B}$ at point P is perpendicular directed downwards represented by the symbol (\times) and point Q field is directed in upward direction represented by the symbol (\bullet)
- The magnitude of magnetic field is

$$dB = \left(\frac{\mu_0}{4\pi} \right) \frac{I |d\mathbf{l}| \sin \theta}{r^2} \quad (2)$$

where θ is the angle between the line element $d\mathbf{l}$ and radius vector \mathbf{r}

The resultant field at point P due to whole conductor can be found by integrating equation (1) over the length of the conductor i.e.

$$\mathbf{B} = \int d\mathbf{B}$$

- **Magnetic field at distance r from an infinitely long straight conductor carrying current I and having N no. of turns is,**

$$\mathbf{B} = \frac{\mu_0 N}{2\pi r} \mathbf{I}$$

- **Magnetic field at the centre of a circular Coil of radius r and N no. of turns carrying current I is,**

$$\mathbf{B} = \frac{\mu_0 N}{2r} \mathbf{I}$$

Effect of magnetic field on charged particles in motion:-

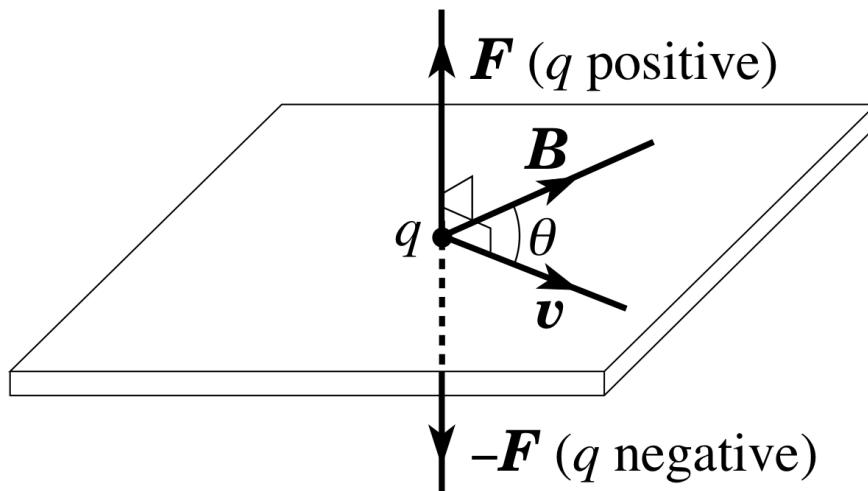

Let us consider a charge q moving through a uniform magnetic field \vec{B} with a velocity \vec{v} in such a way that the direction of motion of charge makes an angle θ with the direction of field.

The charge q experiences a force \vec{F} given by,

$$\vec{F} = q (\vec{v} \times \vec{B})$$

$$\Rightarrow \vec{F} = q v B \sin\theta \hat{n}$$

Where, \hat{n} = Unit vector in a direction perpendicular to the plane containing \vec{v} and \vec{B} .

Thus the magnitude of force $|\vec{F}| = q v B \sin\theta$,

i. If, $v = 0$, then $|\vec{F}| = 0$. Hence no force is experienced by a charge lying at rest in the magnetic field.

ii. If, $\theta = 0^\circ$ or 180° , $|\vec{F}| = 0$. Hence no force is experienced by a charge moving along a line parallel or antiparallel to the direction of lines of force of the field.

iii. If, $\theta = 90^\circ$, $|\vec{F}| = F_{\max} = q v B$. Hence maximum force is experienced by a charge moving perpendicular to the direction of lines of force of the field.

MOTION OF A CHARGED PARTICLE IN A MAGNETIC FIELD

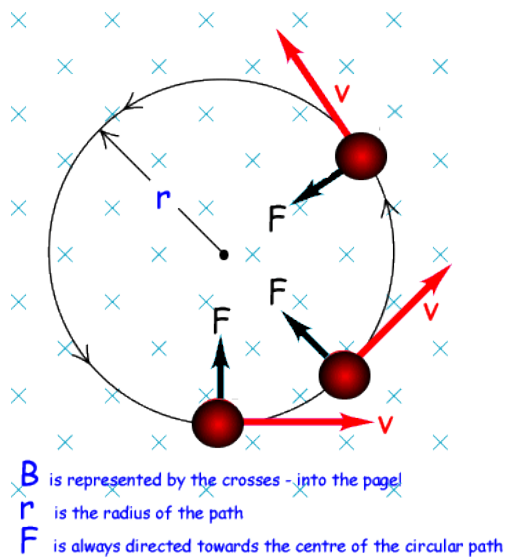

Suppose that a particle of mass m moves in a circular orbit of radius r with a constant speed v . The acceleration of the particle is of magnitude mv^2/r , and is always directed towards the centre of the orbit. It follows that the acceleration is always perpendicular to the particle's instantaneous direction of motion.

We have seen that the force exerted on a charged particle by a magnetic field is always perpendicular to its instantaneous direction of motion. Suppose that a particle of positive charge q and mass m moves in a plane perpendicular to a uniform magnetic field B . In the figure, the field points into the plane of the paper. Suppose that the particle moves, in an anti-clockwise manner, with constant speed v , in a circular orbit of radius r . The magnetic force acting on the particle is of magnitude $F = qvB$ and this force is always directed towards the centre of the orbit. Thus, if

$$F = qvB = \frac{mv^2}{r}$$

It follows that, $r = \frac{mv}{qB}$

The angular frequency of rotation of the particle (*i.e.*, the number of radians the particle rotates through in one second) is

$$\omega = \frac{v}{r} = \frac{qB}{m}$$

Force acting on a current carrying straight conductor placed in a uniform magnetic field. :-

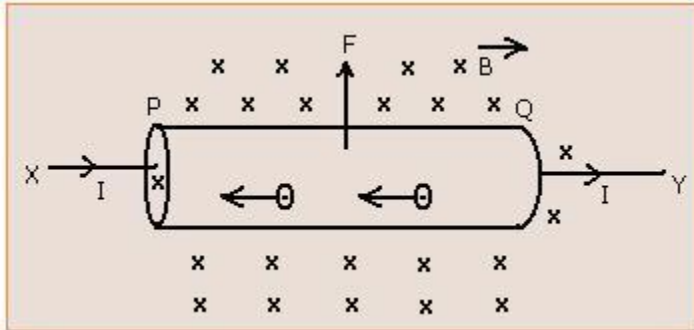

A conductor has free electrons in it. When a potential difference is maintained across the two ends of the conductor, the electrons drift from lower to higher potential with a small velocity and current flows in the conductor. When the electrons move in a magnetic field, they experience a force \vec{F} .

Let us consider a conductor XY placed in a uniform magnetic field \vec{B} acting inwards at right angle to the plane of paper.

Let, I = Current flowing through the conductor from X to Y.

\vec{v} = Velocity of the moving charge

dq = small amount of charge moving from x to Y

Force experienced by the charge is,

$$d\vec{F} = dq (\vec{v} \times \vec{B})$$

If the charge moves a small distance dl in time dt ,

$$\text{Then, } d\vec{F} = dq \left(\frac{d\vec{l}}{dt} \times \vec{B} \right) = \frac{dq}{dt} (d\vec{l} \times \vec{B}) = I (d\vec{l} \times \vec{B})$$

Direction of length $d\vec{l}$ is considered as the direction of flow of current from x to Y.

Net force acting on the conductor will be, $\vec{F} = I (\vec{l} \times \vec{B}) = I l B \sin\theta \hat{n}$

Where, \hat{n} = Unit vector in a direction perpendicular to the plane containing \vec{l} and \vec{B} .

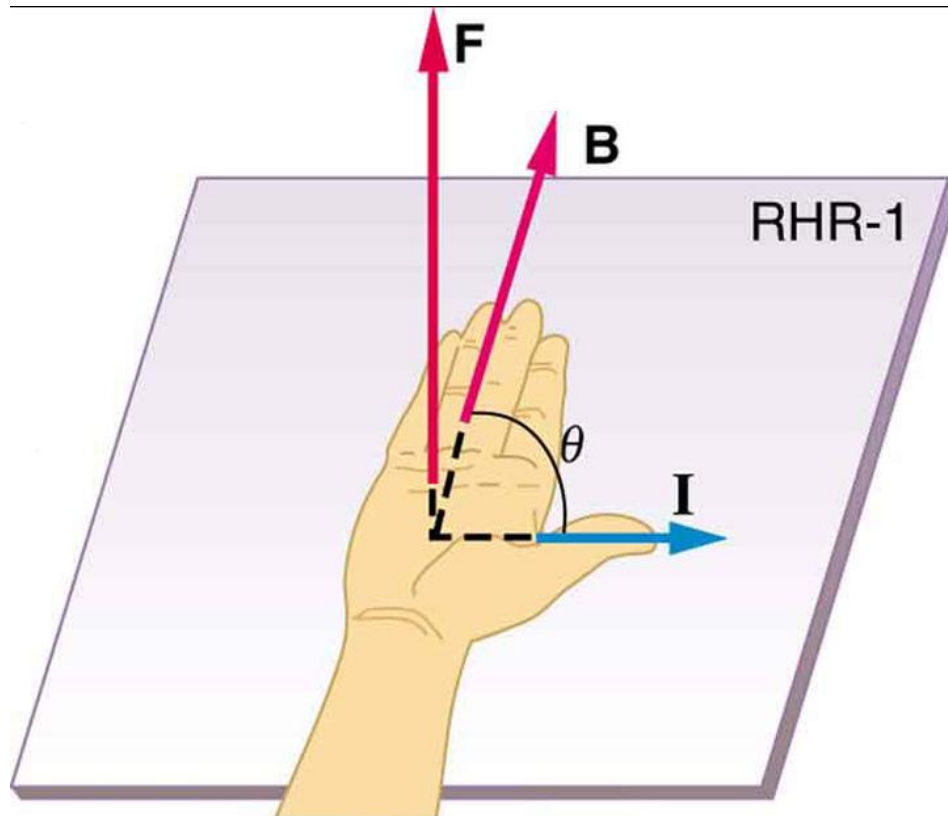

$$F = I l B \sin \theta$$

$\mathbf{F} \perp$ plane of \mathbf{I} and \mathbf{B}

Thus magnitude of Force depends upon the angle between current I and magnetic field B .

Direction of Force is determined by Fleming's Left Hand Rule

FLEMING'S LEFT HAND RULE:-

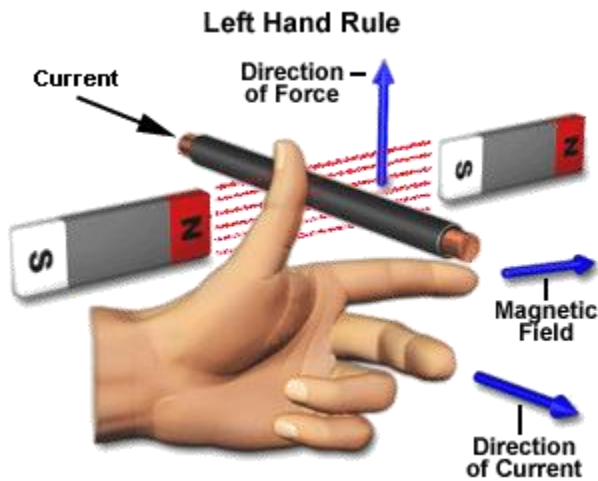

- When current flows in a wire, and an external magnetic field is applied across that flow, the wire experiences a force perpendicular both to that field and to the direction of the current flow.
- Direction of Force is determined by Fleming's Left Hand Rule
- The left hand rule is applicable for motors.
- STATEMENT :- Stretch out the left hand with forefinger, central finger and thumb at right angle to one another.
 - i) **Thumb** represents the direction of the Thrust on the conductor / Motion of the Conductor.
 - ii) **The Fore finger** represents the direction of the magnetic Field
 - iii) **The Central finger** represents the direction of the Current.

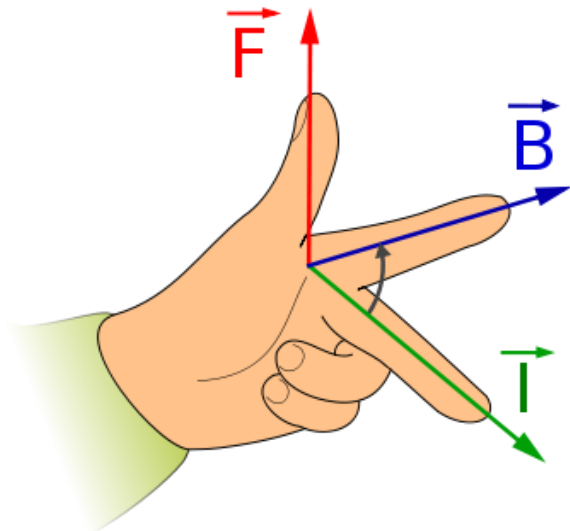

Distinction between the right-hand and left-hand rule

- Fleming's left-hand rule is used for [electric motors](#),
- Fleming's right-hand rule is used for [electric generators](#).

- Different hands need to be used for motors and generators because of the differences between cause and effect.

- In an electric motor, the electric current and magnet field exist (which are the causes), and they lead to the force that creates the motion (which is the effect), and so the left hand rule is used.
- In an electric generator, the motion and magnetic field exist (causes), and they lead to the creation of the electric current (effect), and so the right hand rule is used.

il

UNIT-9

ELECTROMAGNETIC INDUCTION

ELECTROMAGNETIC INDUCTION

- Electromagnetic Induction is the process in which an E.M.F. is setup in a coil placed in a magnetic field whenever the flux through the coil changes. If the coil forms a part of a close circuit, the E.M.F. causes a current to flow in the circuit.
- E.M.F. setup in the coil is called "induced E.M.F" and the current thus produced is termed as "Induced Current".
- Experiments show that the magnitude of E.M.F. depends on the rate at which the flux through the coil changes. It also depends on the number of turns on the coil.
- There are various ways to change magnetic flux of a coil such as;
 - (1) By changing the relative position of the coil with respect to a magnet.
 - (2) By changing current in the coil itself.
 - (3) By changing current in the neighbouring coil.
 - (4) By changing area of a coil placed in the magnetic field etc.

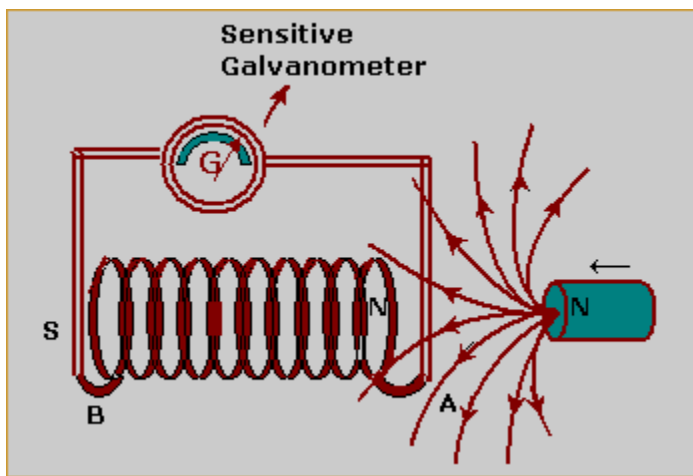

FARADAY'S LAW OF ELECTROMAGNETIC INDUCTION

Faraday was the first scientist who performed a number of experiments to discover the facts and figures of electromagnetic induction, he formulated the following laws:

FARADAY'S 1st LAW:- When magnetic flux changes through a circuit, an emf is induced in it.

FARADAY'S 2nd LAW :-The induced emf lasts only as long as the change in the magnetic flux through the circuit continues.

FARADAY'S 3rd LAW:- Induced emf is directly proportional to the rate of change of magnetic flux through the coil. i.e.

$$\text{Average emf} = e = -N\Delta\phi/\Delta t$$

Where N = number of turns in the coil.

$\Delta\phi$ = Change in magnetic flux

Δt = time elapsed

The negative sign indicates that the induced current is such that the magnetic field due to it opposes the magnetic flux producing it.

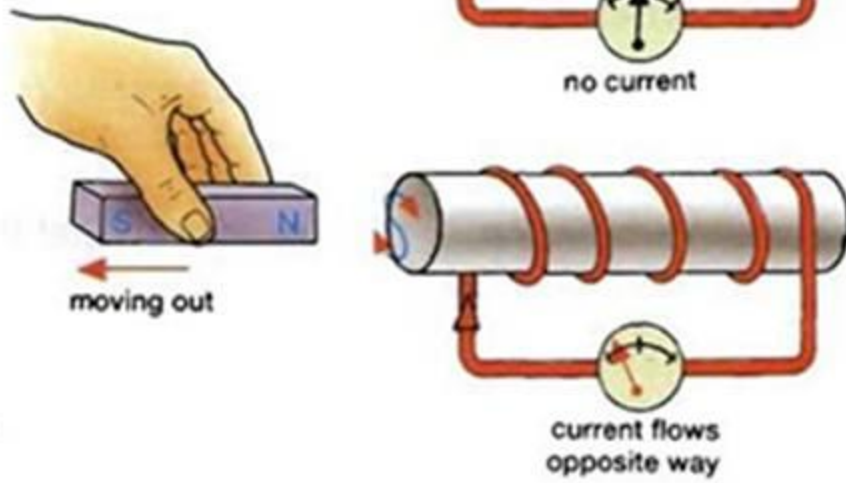
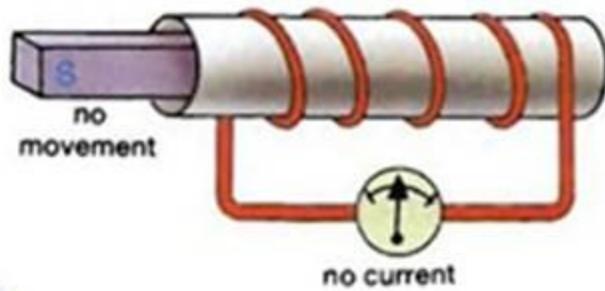
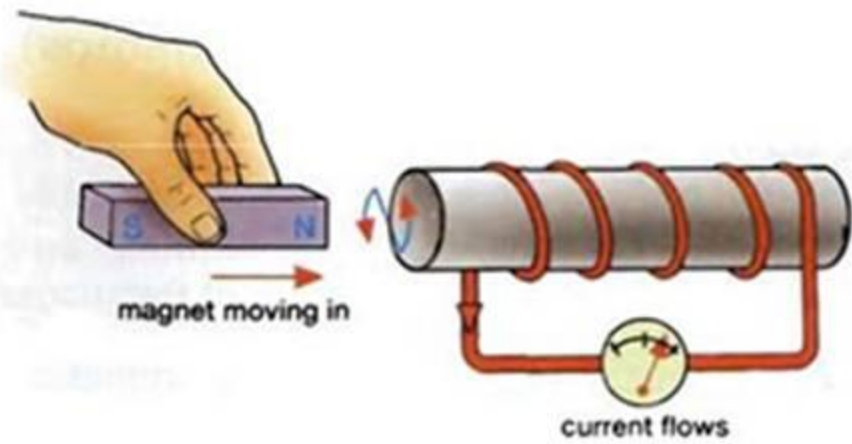

LENZ'S LAW

Lenz's law describes that in order to produce an induced emf or induced current some external source of energy must be supplied otherwise no current will induce.

Lenz's law states that"

"The direction of induced current is always such as to oppose the cause which produces it".

That is why a -ve sign is used in Faraday's law.

EXPLANATION

Consider a bar magnet and a coil of wire.

- When the N-pole of magnet is approaching the face of the coil, it becomes a north face by the induction of current in anticlockwise direction to oppose forward motion of the magnet.

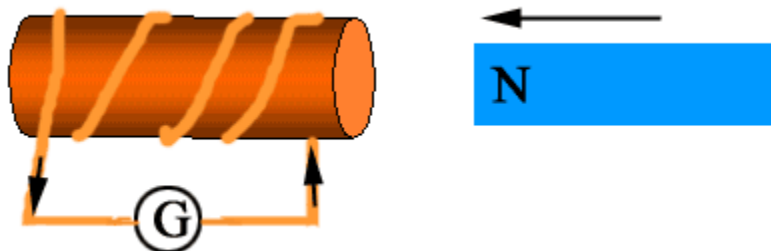

- When the N-pole of the magnet is receding the face of the coil becomes a south pole due to a clockwise induced current to oppose the backward motion.

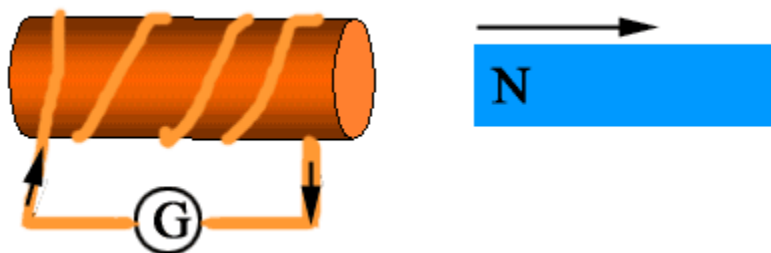

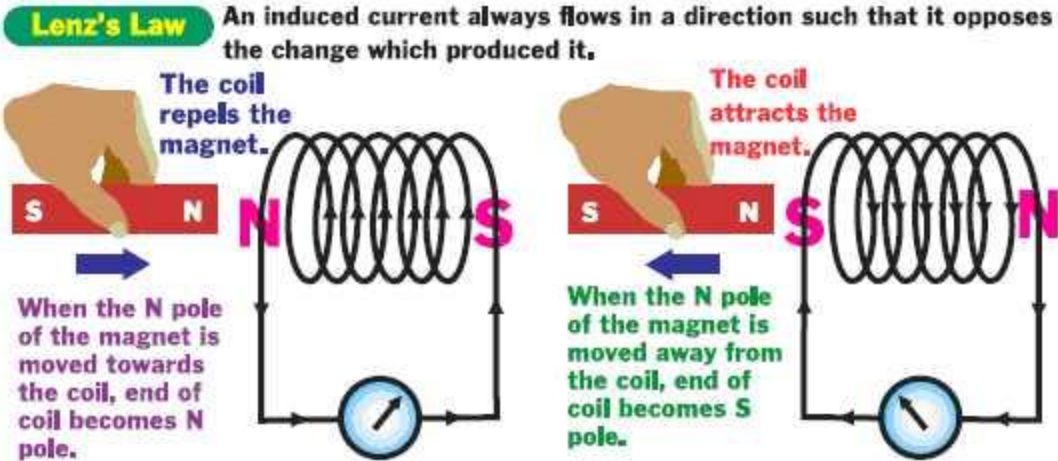

FLEMING'S RIGHT HAND RULE :-

As per [Faraday's law of electromagnetic induction](#), whenever a conductor moves inside a magnetic field, there will be an induced current in it. If this conductor gets forcefully moved inside the magnetic field, there will be a relation between the direction of applied force, magnetic field and the electric current. This relation among these three directions is determined by **Fleming Right Hand rule**

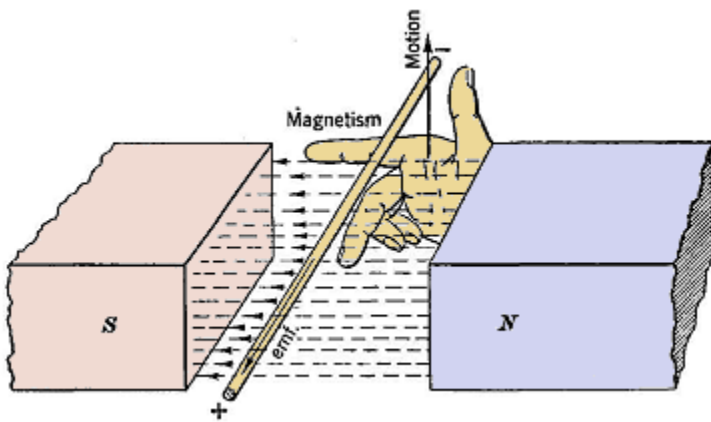

Fleming's right-hand rule is applied to determine the direction of the emf generated in a moving conductor when the direction of the magnetic field and the direction of motion of the conductor in the field are known.

STATEMENT

This rule states "Hold out the right hand with the first finger, second finger and thumb at right angle to each other. Then,

- forefinger represents the direction of the line of force,
- the thumb points in the direction of motion or applied force,
- second finger points in the direction of the induced current

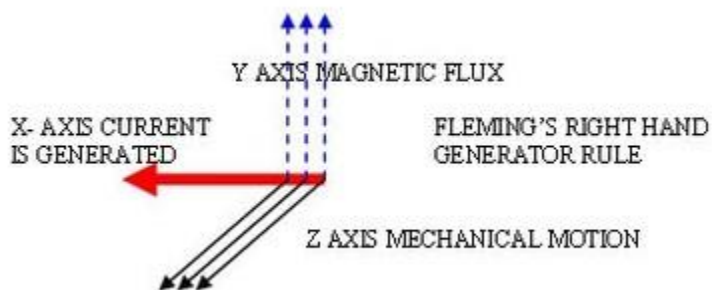
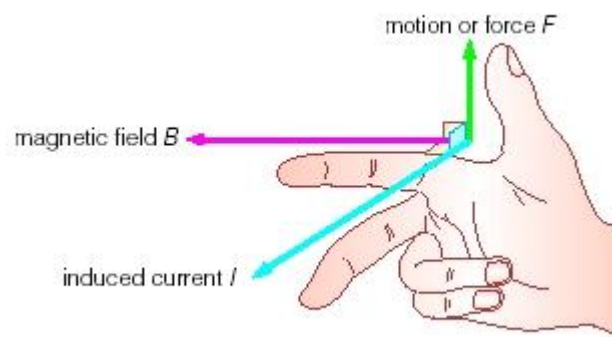

UNIT-10

MODERN

PHYSICS

PHOTO-ELECTRIC EFFECT

CONCEPT :-

Photo-electric effect is the phenomenon of emission of electrons from the surfaces of certain substances, mainly metals, when light of shorter wavelength is incident upon them.

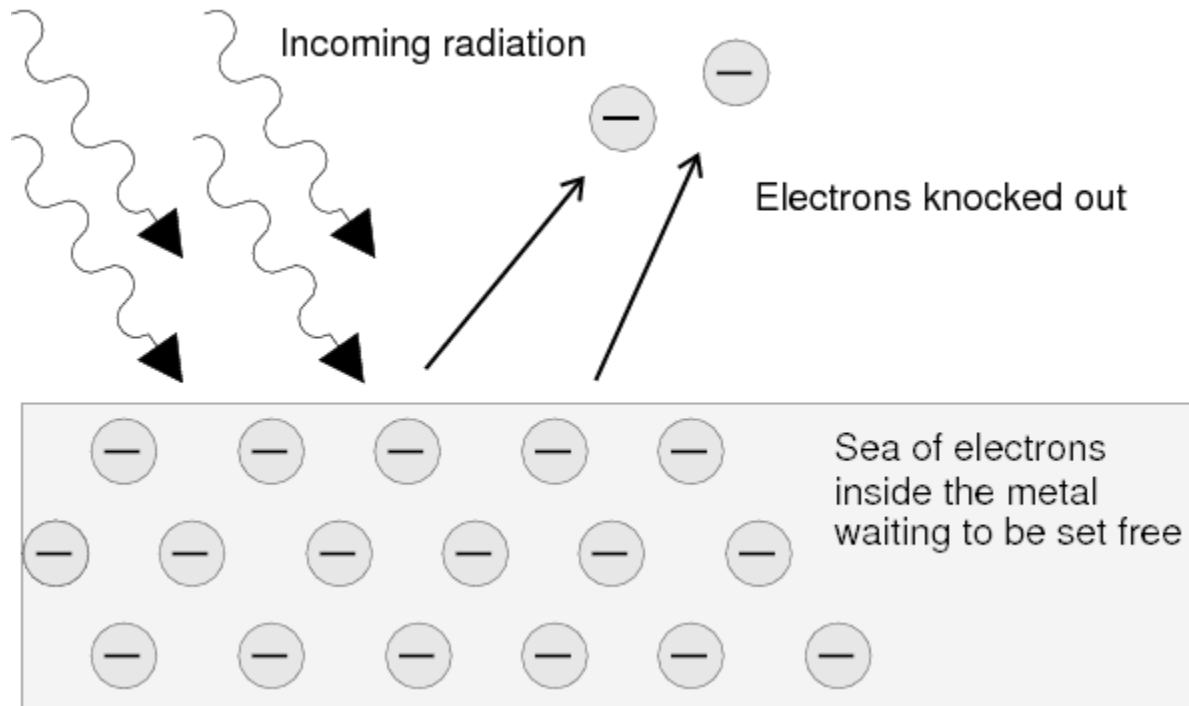

Experimental observations of photoelectric emission

The theory of the photoelectric effect must explain the experimental observations of the emission of electrons from an illuminated metal surface.

When light of frequency greater than the threshold frequency of the cathode material falls on the cathode, photoelectrons are emitted. These electrons are collected by the anode and an electric current starts flowing in the external circuit. The current increases with the increase in the intensity of light. The current would stop, if the light does not fall on the cathode.

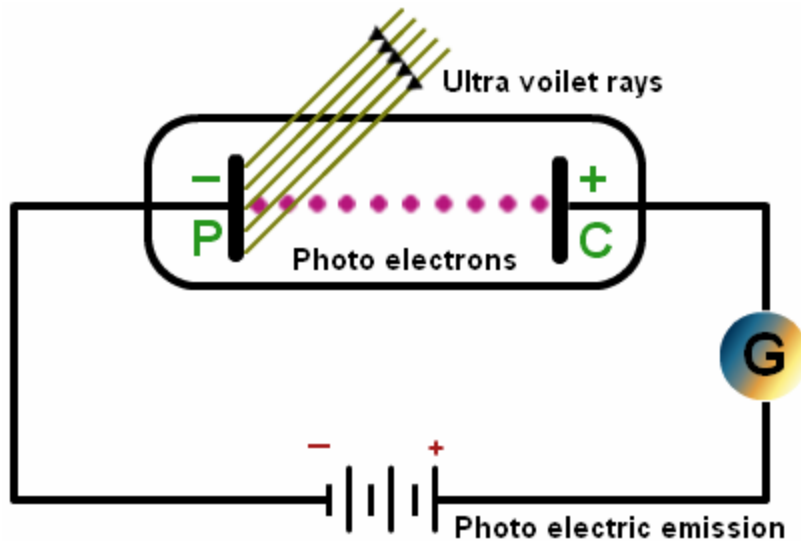

- For electron emission, the photon's energy has to be greater than the work function(w) .
- For every metal there is a threshold frequency, f_0 , where $hf_0 = W$ that gives the photon enough energy to produce photoemission.
- The number of photoelectrons emerging from the metal surface per unit time is proportional to the number of photons striking the surface that in turn depends on the intensity of the incident radiation
- It follows that the photo electric current is proportional to the intensity of the radiation provided the frequency of radiation is above threshold frequency.
- The time lag between the incidence of radiation and the emission of a photoelectron is very small, less than 10^{-9} second.

EINSTEIN'S PHOTOELECTRIC EQUATION:-

- Einstein said that light travels in tiny packets called quanta. (Singular form is quantum)
- The energy of each quanta is given by its frequency

$$E = hf$$

Energy → E ← frequency
 Planck's constant → h

- Each metal has a minimum energy needed for an electron to be emitted known as the *work function*, W .
- For an electron to be emitted, the energy of the photon, hf , must be greater than the work function, W .

The excess energy is the *kinetic energy*, K of the emitted electron

The maximum kinetic energy K_{\max} of an ejected electron is given by,

$$K_{\max} = hf - W,$$

Where, $h =$ Planck constant

$f =$ Frequency of the incident photon.

$W =$ work function, which gives the minimum energy required to remove an electron from the surface of the metal.

The work function satisfies

$$W = hf_0$$

Where, $f_0 =$ Threshold frequency for the metal.

The maximum kinetic energy of an ejected electron is then

$$K_{\max} = h(f - f_0).$$

Kinetic energy is positive, so we must have $f > f_0$ for the photoelectric effect to occur.

LAWS OF PHOTOELECTRICITY :-

- Photoelectric effect is an instantaneous process.
- Photoelectric current is directly proportional to the intensity of incident light and is independent of its frequency.
- The stopping potential and hence the maximum velocity of the electrons depends upon the frequency of the light and is independent of its intensity.
- The emission of electron stops below a certain minimum frequency known as threshold frequency.

Applications of Photocell :-

A photocell can be used in any situation where beam of light falling on it is interrupted or broken by any mean.

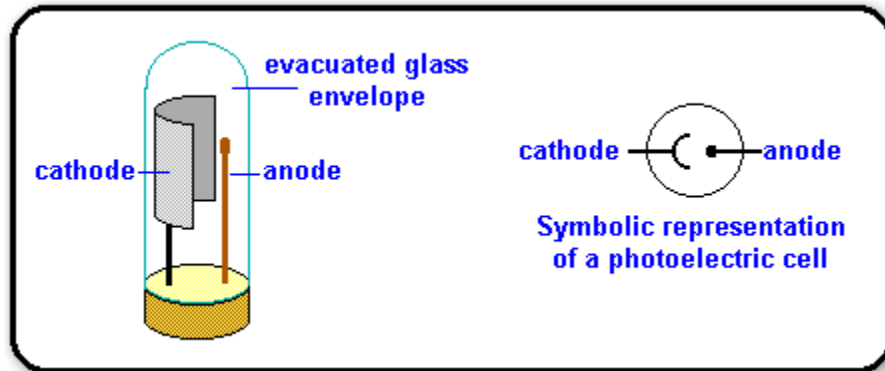

- The photoelectric cell is commonly used to measure light.
 - Camera light meter
- It can also generate electricity.
 - Photovoltaic cell
- It is used in television studio to convert light and shade of the picture into electrical waves.
- It is used for reproduction of sound in films.
- It is used for triggering fire alarms.
- It is also used in operating burglar's alarm.
- It is used for automatic switching of street lights
- It is used to open doors automatically in a building such as banks or other commercial buildings or offices.
- It is used to count items running on a conveyer belt.
- It is used to count vehicles passing a road.

LASER :-

LASER is an acronym for

Light

Amplification by the

Stimulated

Emission of

Radiation

A **laser** is a device that emits light through a process of optical amplification based on the stimulated emission of electromagnetic radiation.

CHARACTERISTICS OF LASER:

- i. **Monochromatic** : The light emitted from a laser is *monochromatic*, that is, it is of one wavelength (color). In contrast, ordinary white light is a combination of many different wavelengths (colors).



- ii. **Directional:** Lasers emit light that is highly *directional*. Laser light is emitted as a relatively narrow beam in a specific direction. Ordinary light, such as coming from the sun, a light bulb, or a candle, is emitted in many directions away from the source.

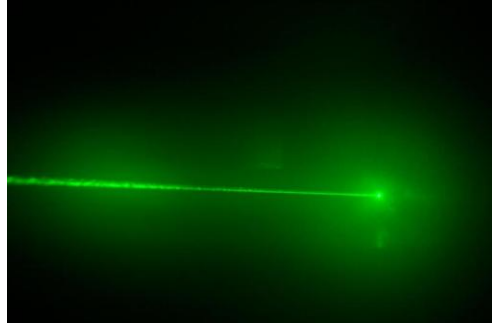

Coherent : The light from a laser is said to be *coherent*, which means the wavelengths of the laser light are in phase in space and time.

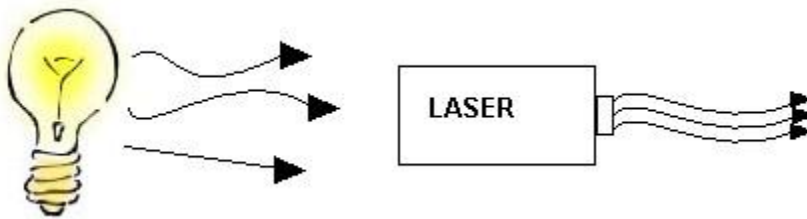

These three properties of laser light are what make it more of a hazard than ordinary light. Laser light can deposit a great deal of energy within a very small area.

PRINCIPLE OF LASER:

The principle of a laser is based on three separate features:

- Stimulated emission within an amplifying medium,
- Population inversion of electrons
- Optical resonator.

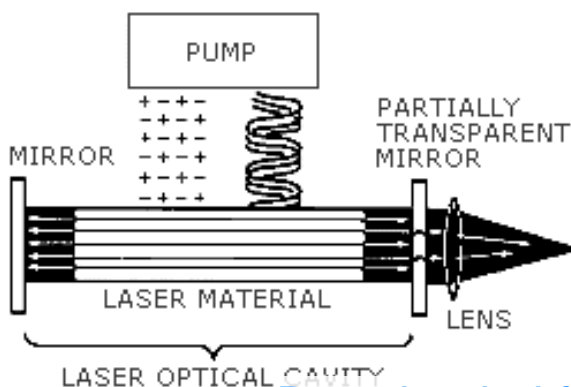

a) Spontaneous Emission and Stimulated Emission

Spontaneous Emission:-According to the quantum mechanics, an electron within an atom can have only certain values of energy, or energy levels. There are many energy levels that an electron can occupy. If an electron is in the excited state with the energy E_2 it may spontaneously decay to the ground state, with energy E_1 , releasing the difference in energy between the two states as a photon. This process is called **spontaneous emission**, producing fluorescent light. The phase and direction of the photon in spontaneous emission are completely random due to Uncertainty Principle.

Conversely, a photon with a particular frequency would be absorbed by an electron in the ground state. The electron remains in this excited state for a period of time typically less than 10^{-6} second. Then it returns to the lower state spontaneously by a photon or a phonon. These common processes of absorption and spontaneous emission cannot give rise to the amplification of light. The best that can be achieved is that for every photon absorbed, another is emitted.

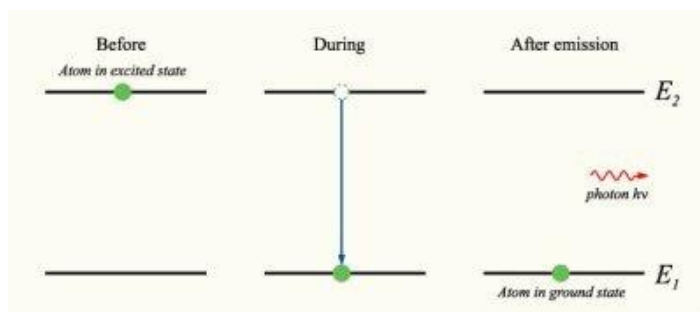

Stimulated Emission:- If the excited-state atom is perturbed by the electric field of a photon with frequency ω , it may release a second photon of the same frequency, in phase with the first photon. The atom will again decay into the ground state. This process is known as stimulated emission.(see Fig.2b)

The emitted photon is identical to the stimulating photon with the same frequency, polarization, and direction of propagation. And there is a fixed phase relationship between light radiated from different atoms. The photons, as a result, are totally coherent. This is the critical property that allows optical amplification to take place.

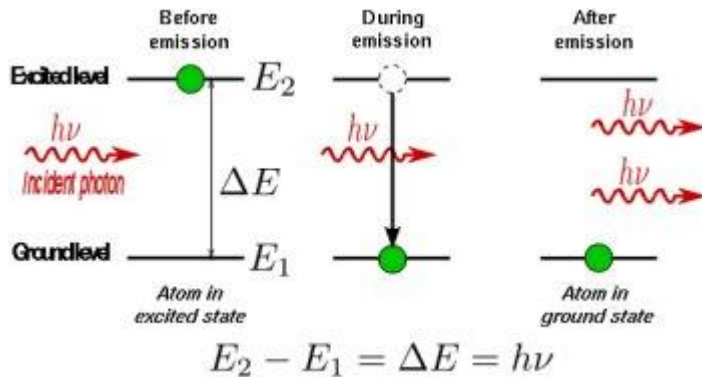

b) Population Inversion of the Gain Medium :-

If the higher energy state has a greater population than the lower energy state, then the light in the system undergoes a net increase in intensity. And this is called population inversion. But this process cannot be achieved by only two states, because the electrons will eventually reach equilibrium with the de-exciting processes of spontaneous and stimulated emission.

Instead, an indirect way is adopted, with three energy levels ($E_1 < E_2 < E_3$) and energy population N_1 , N_2 and N_3 respectively. (see Fig.3a) Initially, the system is at thermal equilibrium, and the majority of electrons stay in the ground state. Then external energy is provided to excite them to level 3, referred as pumping. The source of pumping energy varies with different laser medium, such as electrical discharge and chemical reaction, etc.

In a medium suitable for laser operation, we require these excited atoms to quickly decay to level 2, transferring the energy to the phonons of the lattice of the host material. This wouldn't generate a photon, and labeled as R, meaning radiation less. Then electrons on level 2 will decay by spontaneous emission to level 1, labeled as L, meaning laser. If the life time of L is much longer than that of R, the population of the E_3 will be essentially zero and a population of excited state atoms will accumulate in level 2. When level 2 hosts over half of the total electrons, a population inversion be achieved.

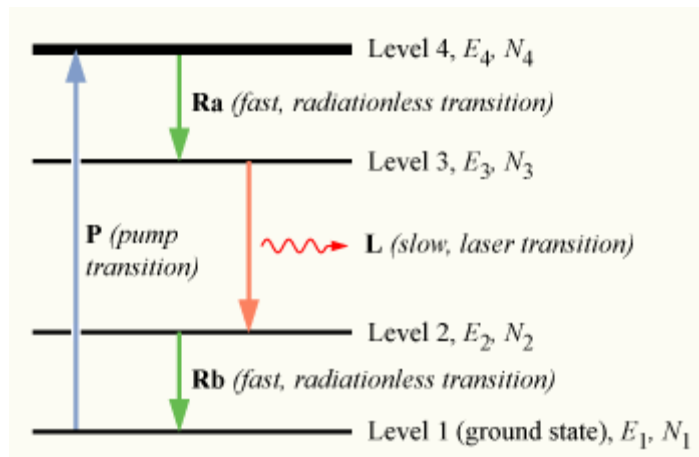

Fig.3 Electron Transitions within 4-level gain medium

Because half of the electrons must be excited, the pump system need to be very strong. This makes three-level lasers rather inefficient. Most of the present lasers are 4-level lasers. The population of level 2 and 4 are 0 and electrons just accumulate in level 3. Laser transition takes place between level 3 and 2, so the population is easily inverted.

c) Optical Resonator

Although with a population inversion we have the ability to amplify a signal via stimulated emission, the overall single-pass gain is quite small, and most of the excited atoms in the population emit spontaneously and do not contribute to the overall output. Then the resonator is applied to make a positive feedback mechanism.

An optical resonator usually has two flat or concave mirrors, one on either end, that reflect lasing photons back and forth so that stimulated emission continues to build up more and more laser light. Photons produced by spontaneous decay in other directions are off axis so that they won't be amplified to compete with stimulated emission on axis. The "back" mirror is made as close to 100% reflective as possible, while the "front" mirror typically is made only 95 - 99% reflective so that the rest of the light is transmitted by this mirror and leaks out to make up the actual laser beam outside the laser device.

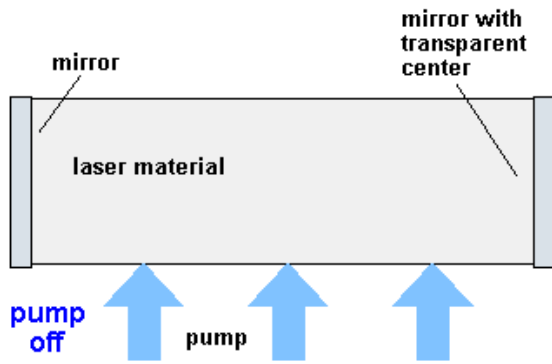

When laser is pumped, photons are spontaneously emitted as excited electrons return to lower energy levels.

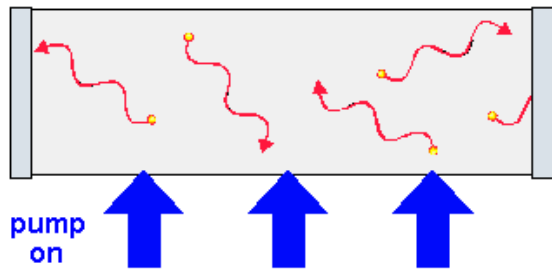

Photons reflect off mirrors and start to stimulate other electrons to emit their photons.

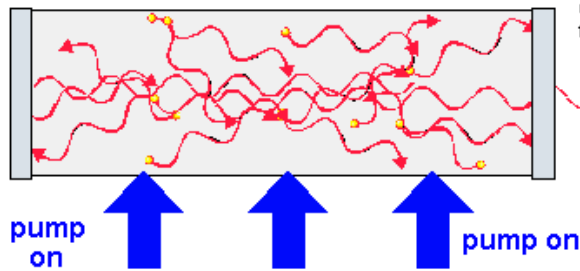

A chain reaction of photons begins and the laser begins to "lase."

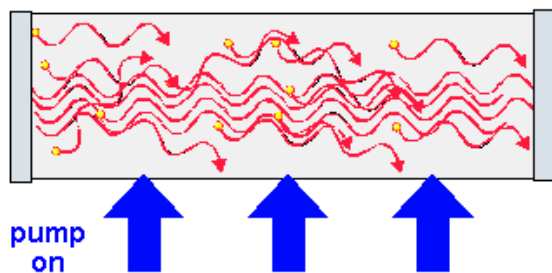

Full operation.

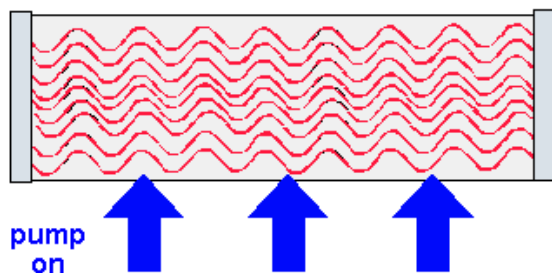

APPLICATIONS OF LASER:

Lasers have many important applications.

- ❖ They are used in common consumer devices such as [optical disk drives](#), [laser printers](#), and [barcode scanners](#).
- ❖ Lasers are used for both [fiber-optic](#) and [free-space optical communication](#).
- ❖ They are used in medicine for [laser surgery](#) and various skin treatments,
- ❖ Lasers are used in industry for cutting and [welding](#) materials.
- ❖ They are used in military and [law enforcement](#) devices for marking targets and [measuring range](#) and speed.
- ❖ [Laser lighting displays](#) use laser light as an entertainment medium.